

TREND
LAMINATES | PLY | PVC

P R E M I U M
PVC LAMINATES



P R E M I U M
PVC LAMINATES

TREND
LAMINATES | PLY | PVC

COLLECTION
2023-24

TREND
LAMINATES | PLY | PVC

Edge Banding Tape | Acrylic High Gloss Laminates | Korean Charcoal Panels | PVC Flex High Gloss Laminates | WPC & PVC Boards | High Definition Digital Laminates | Weiya Stone (Alabaster Sheets) | Decorative Laminates | Plywood & Flush Doors | 3D PVC Panel | PVC Fabric Premium Laminates

Customer Care no.: +91-11 40396922
Email: info@trendpvc.com

Follow us: [f](https://www.facebook.com/trend.laminates) [@](https://www.instagram.com/trend.laminates) /trend.laminates
for e-catalogue visit us: www.trendpvc.com

COLLECTION
2023-24

THE
PVC
COLLECTION



C O N T E N T

Introduction	03
PETG Laminates	02
Shimmer Series	12
Sparkle Collection	18
Veneer Collection	28
Fabric Collection	38
Rust Series	46
Marble Series	58
French Stone	64
PVC CORE Laminates	70

T T R E N D

Sh. Vinod Goel established the TCS group in 1984, starting by simply trading in plywood in the Delhi/NCR region. Trend PVC is a TCS group family-owned and operated manufacturing company dedicated to providing innovative surfaces for the industrial, hospitality, and retail businesses. Trend is a pioneer in the field of architectural materials, and we are well-known throughout the country for producing high-quality external louvers, PVC laminates, HD Acrylic Laminates, and charcoal panels. Trend's primary focus is product development, which combines high-quality production technology with intelligent solutions for architectural and industrial surface applications. We, at Trend, are passionate about creating innovative, aesthetically beautiful, and high-performance solutions for a wide range of purposes, due to unique insights into significant market issues, developments, and expectations. Our vision is to deliver exceptional design solutions and excellent customer service, as well as to develop long-term relationships, through our commitment to steady improvement and our sound business principles.

I N T R O D U C T I O N

PETG LAMINATES



Trend PETG laminates, developed specifically for the sophisticated tastes of architects, interior designers, and lifestyle enthusiasts using Japanese technology, are offered in an intriguing choice of colors, patterns, hues, textures, and other distinguishing aspects. These High-Pressure Decorative Laminates are skillfully made to meet a variety of interior requirements, including wall panels, closets, kitchen cabinets, table tops, and more. For the surface styling of interiors, our laminates provide a special solution.

PETG LAMINATES

ANTI- SCRATCH

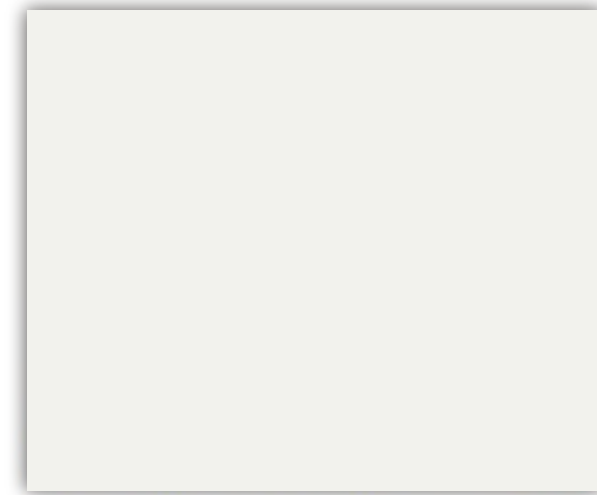

Design no. 291***

ANTI- FADING TECHNOLOGY

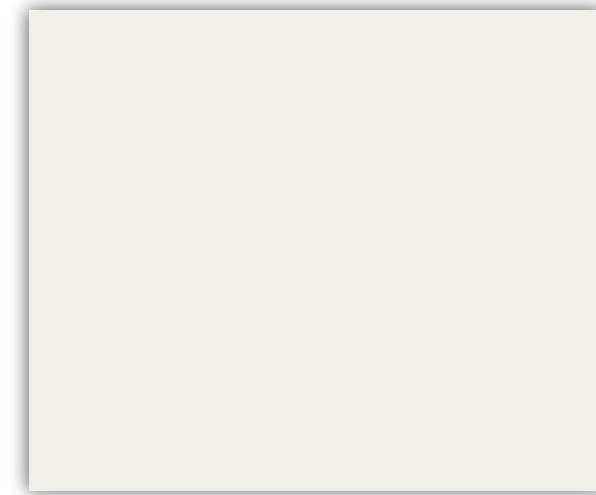

Design no. 292***

4H MIRROR GLOSS

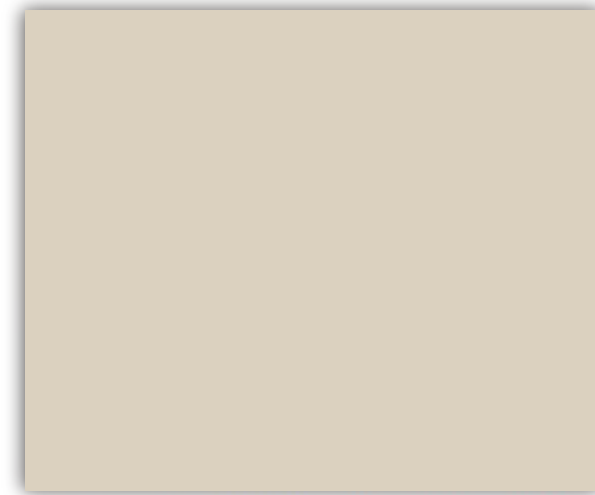

Design no. 293***



Design no. 294***



Design no. 295***



Design no. 296***



Design no. 297***

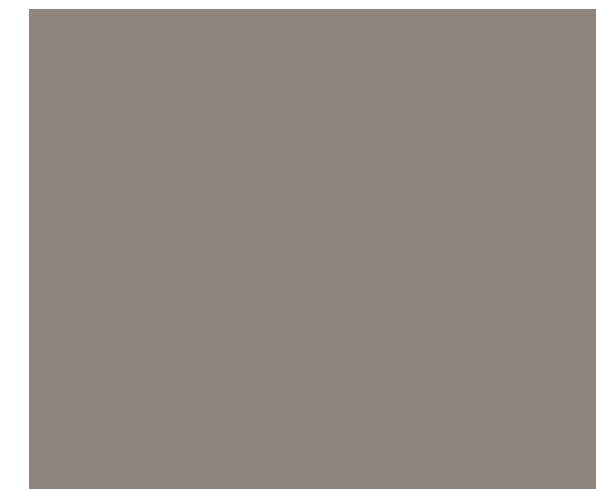

Design no. 298***

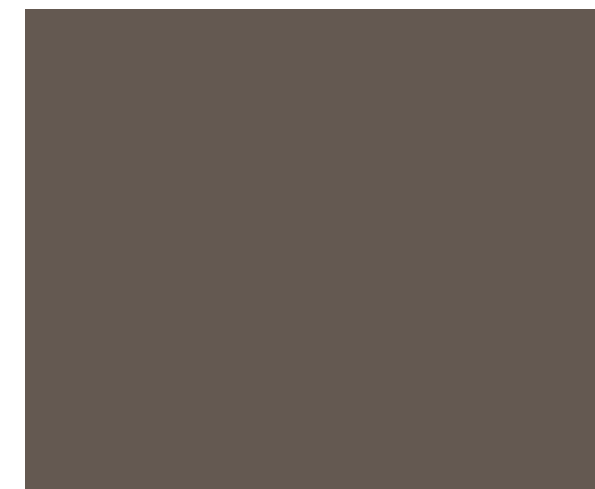

Design no. 299***



Design no. 321***



Design no. 300***



Design no. 322***



Luxury
is when it seems
Flawless



Trend PETG laminates, developed specifically for the sophisticated tastes of architects, interior designers, and lifestyle enthusiasts using Japanese technology, are offered in an intriguing choice of colors, patterns, hues, textures, and other distinguishing aspects. These High-Pressure Decorative Laminates are skillfully made to meet a variety of interior requirements, including wall panels, closets, kitchen cabinets, table tops, and more. For the surface styling of interiors, our laminates provide a special solution.

PETG LAMINATES



Design no. 308 ***



Design no. 309 ***

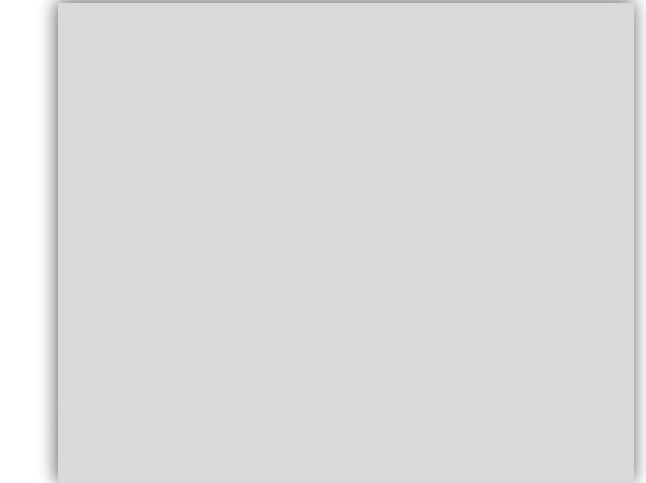

Design no. 310 ***



Design no. 315 ***



Design no. 316 ***



Design no. 317 ***



Design no. 318 ***

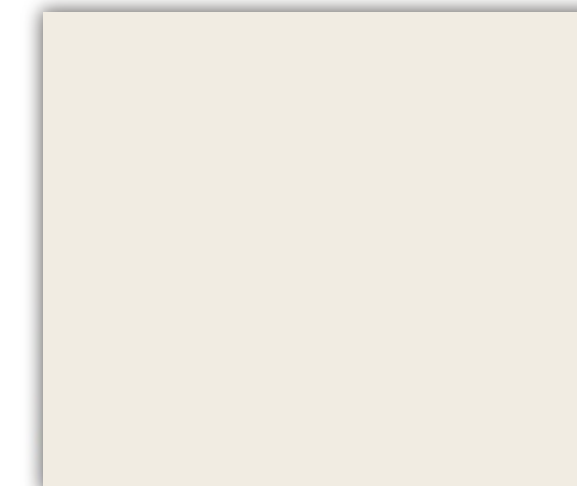

Design no. 319 ***

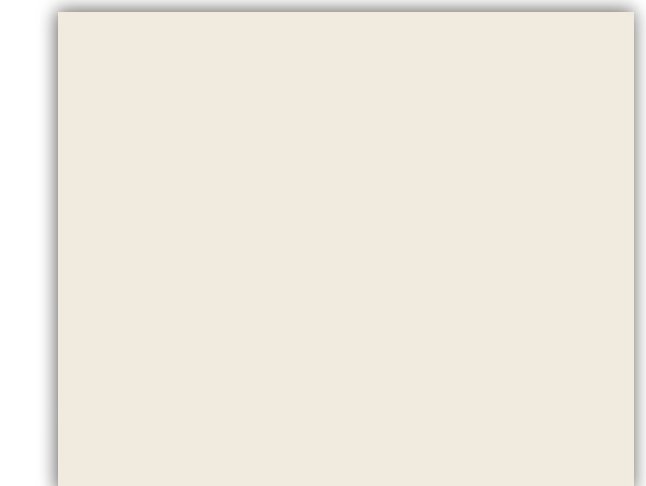

Design no. 320 ***



Design no. 425



Design no. 426



Design no. 427



Design no. 428



Design no. 429



Design no. 430



Design no. 431



Design no. 432



Design no. 433

What is

Modern interior

Modernism is a philosophical movement of the late nineteenth and early twentieth century characterized by abstract thinking that differed from earlier eras' realism, romanticism, and renaissance beliefs. Modernism, particularly in art and architecture, was fashionable from the 1940s until the 1980s. Homes built in the contemporary style during this period included open floor plans, huge glass windows, geometric shapes and patterns, man-made materials, and natural features that demonstrated integration with the outdoors. Most interior designers focus on the usage of industrial features and materials in the home rather than the décor to achieve the minimalist aesthetic that modern design seeks. The features employed are straightforward and give the design a tidy appearance. Consider clean lines, minimalism, and color palettes that are neutral in tone.

SHIMMER SERIES



The Shimmer Collection is the most outrageous collection available. Each laminate is meticulously constructed, has a high-quality polish, and adds a lovely spark that instantly brightens any room. These shimmer laminates shine brightly and require less maintenance. The Trend series is strong and fashionable and gives your room a mirror-like shine and withstands abrasion and scuffing well and lasts longer.

SHIMMER SERIES



Design no. 434



Design no. 435

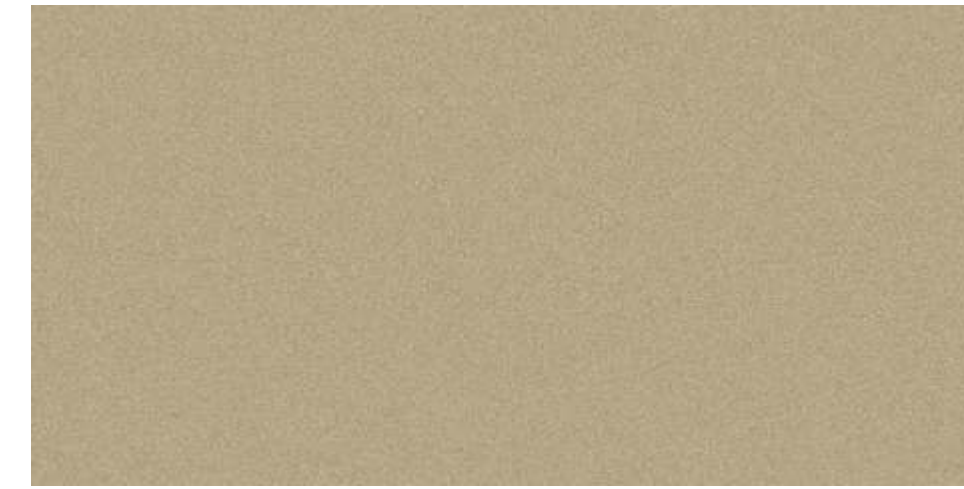

Design no. 401 **

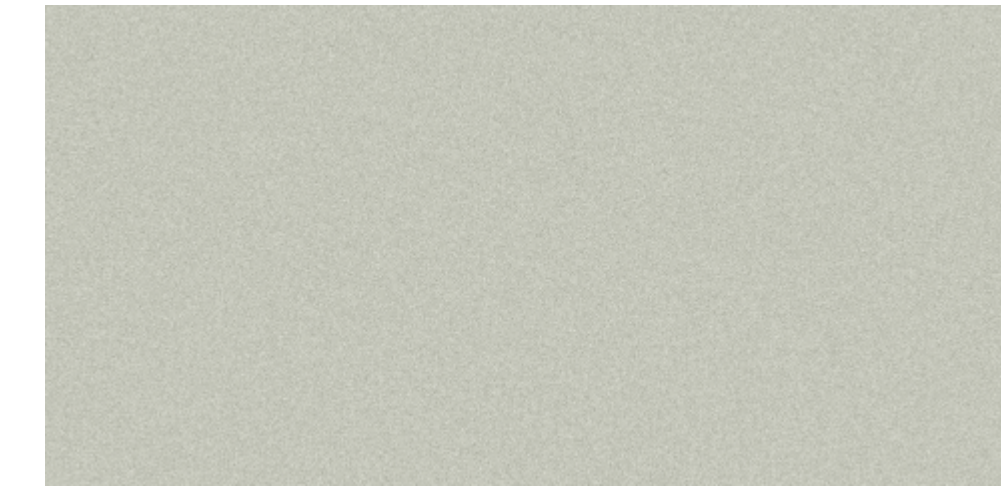

Design no. 402 **

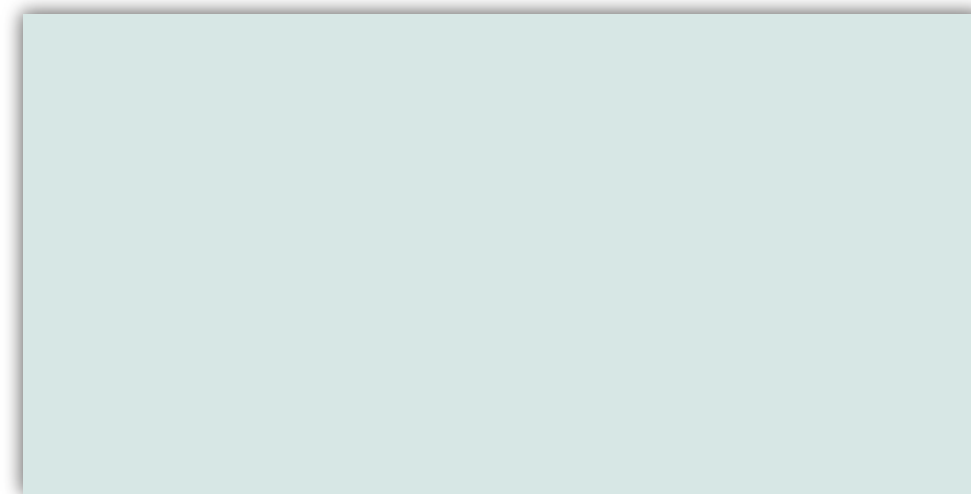

Design no. 436



Design no. 437



Design no. 405 **

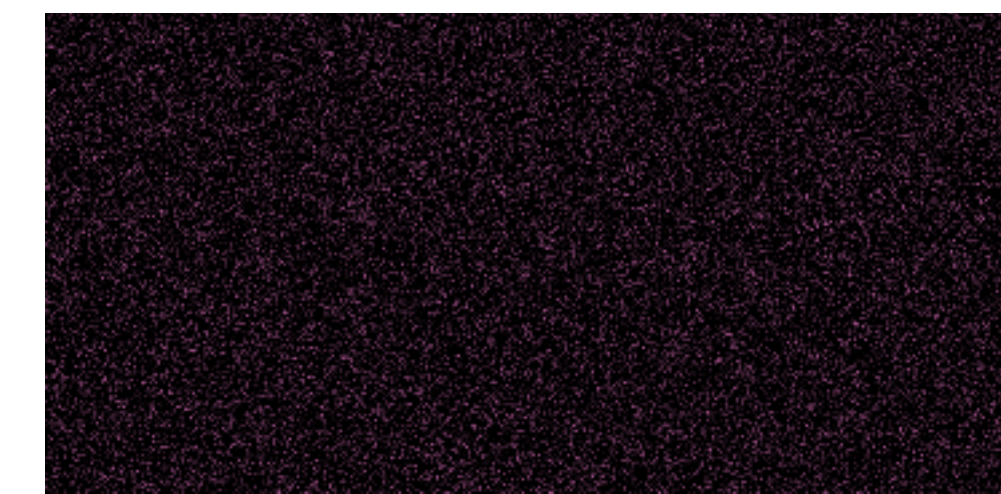

Design no. 406 **

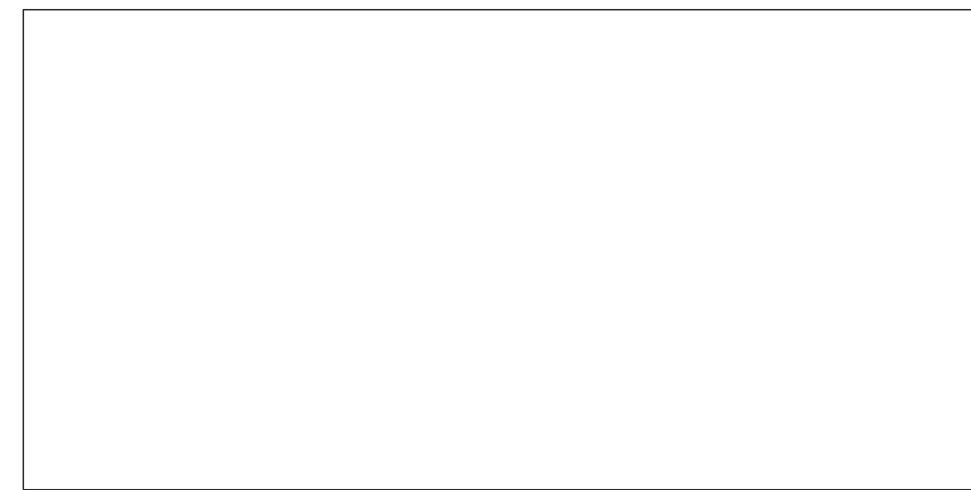

Design no. 438

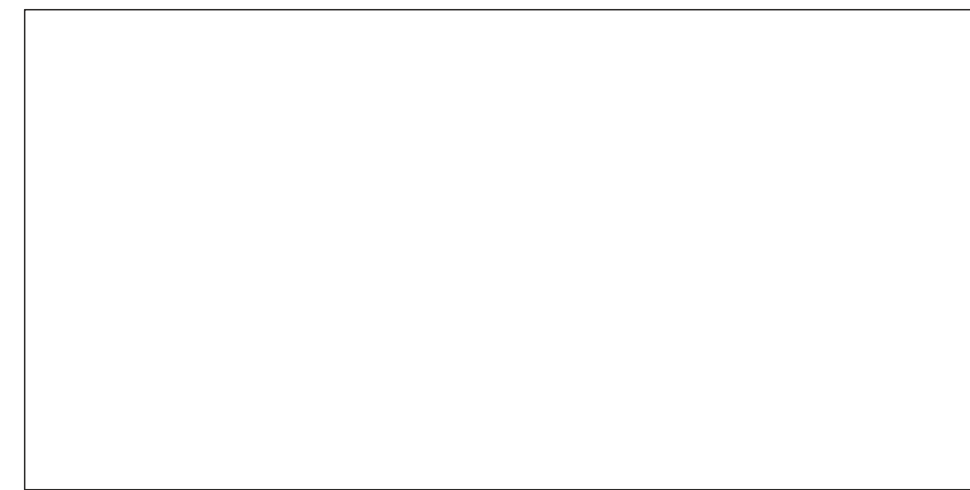

Design no. 439



Design no. 403 **



Design no. 404 **



Design no. 407 **

Guide to your
best selection
of laminates

Premium PVC Collection 2023-24

Modernism is a philosophical movement of the late nineteenth and early twentieth century characterized by abstract thinking that differed from earlier eras' realism, romanticism, and renaissance beliefs. Modernism, particularly in art and architecture, was fashionable from the 1940s until the 1980s. Homes built in the contemporary style during this period included open floor plans, huge glass windows, geometric shapes and patterns, man-made materials, and natural features that demonstrated integration with the outdoors. Most interior designers focus on the usage of industrial features and materials in the home rather than the décor to achieve the minimalist aesthetic that modern design seeks. The features employed are straightforward and give the design a tidy appearance. Consider clean lines, minimalism, and color palettes that are neutral in tone.

INCORPORATE DARKER TONES FOR CONTRAST

Consider using dark tones in contrast to any lighter colors you prefer. Modern house design isn't frightened of brighter colors, so experiment with darker hues like black and charcoal grey. Other modern forms, particularly modern farmhouses, favor the dichotomy of light and dark colors.

1

2

GO FOR A POP COLOR

Consider using dark tones in contrast to any lighter colors you prefer. Modern house design isn't frightened of brighter colors, so experiment with darker hues like black and charcoal grey. Other modern forms, particularly modern farmhouses, favor the dichotomy of light and dark colors.

SPARKLE COLLECTION



Enjoy this wide array of glittery and shiny textures, inspired by shiny and bright stars to mesmerize you with different enthralling impressions in and around your interior surfaces. This Sparkle series keeps you hooked with its originality and adds three-dimensional effects to your interiors spaces.

SPARKLE COLLECTION

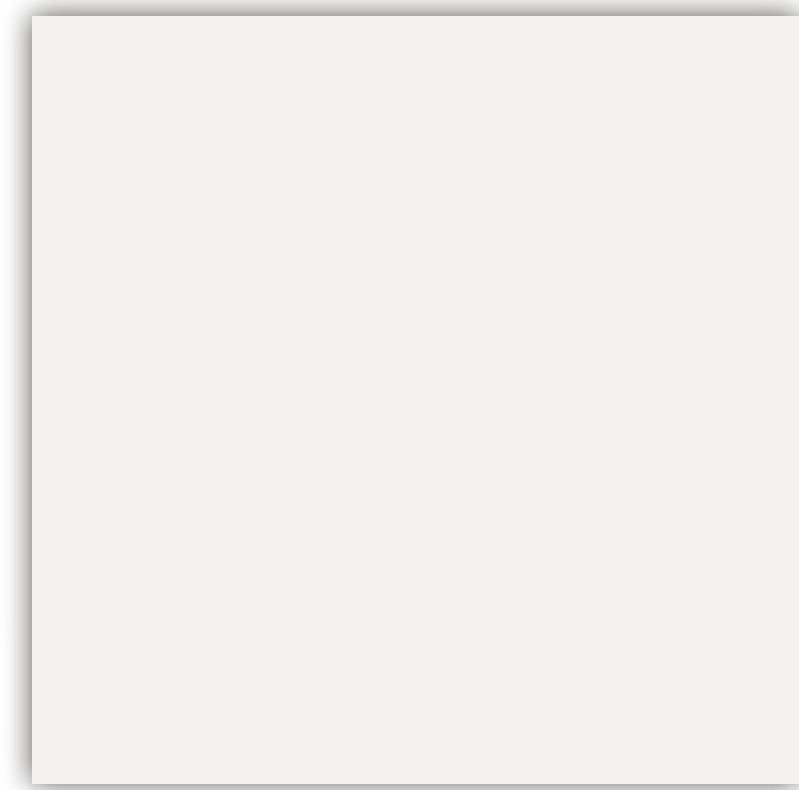

Design no. 232 *



Design no. 233 *



Design no. 234 *

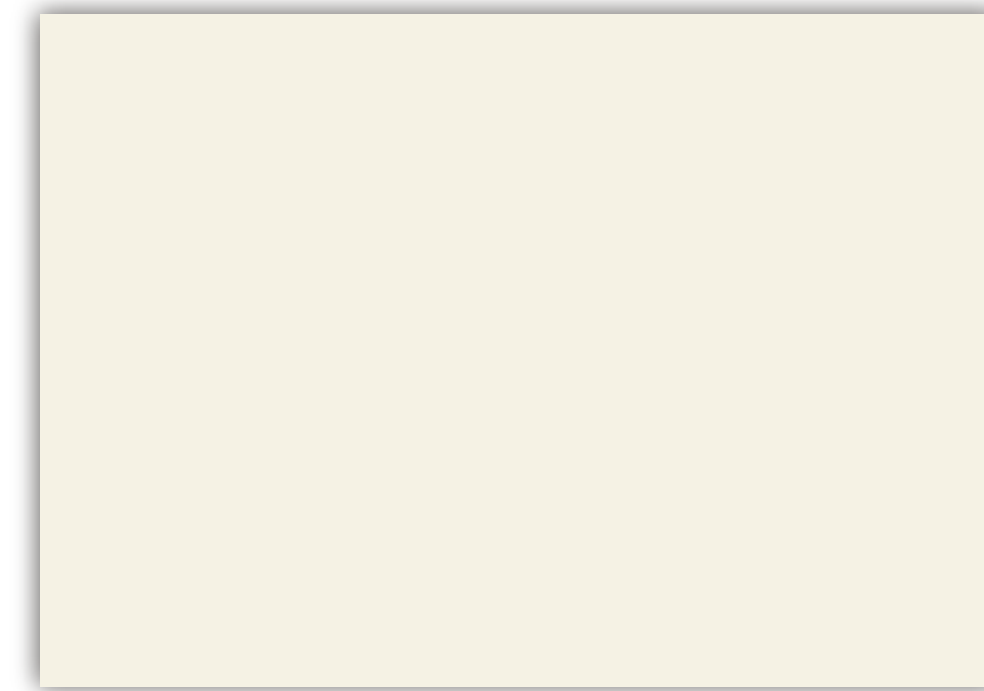

Design no. 410



Design no. 411

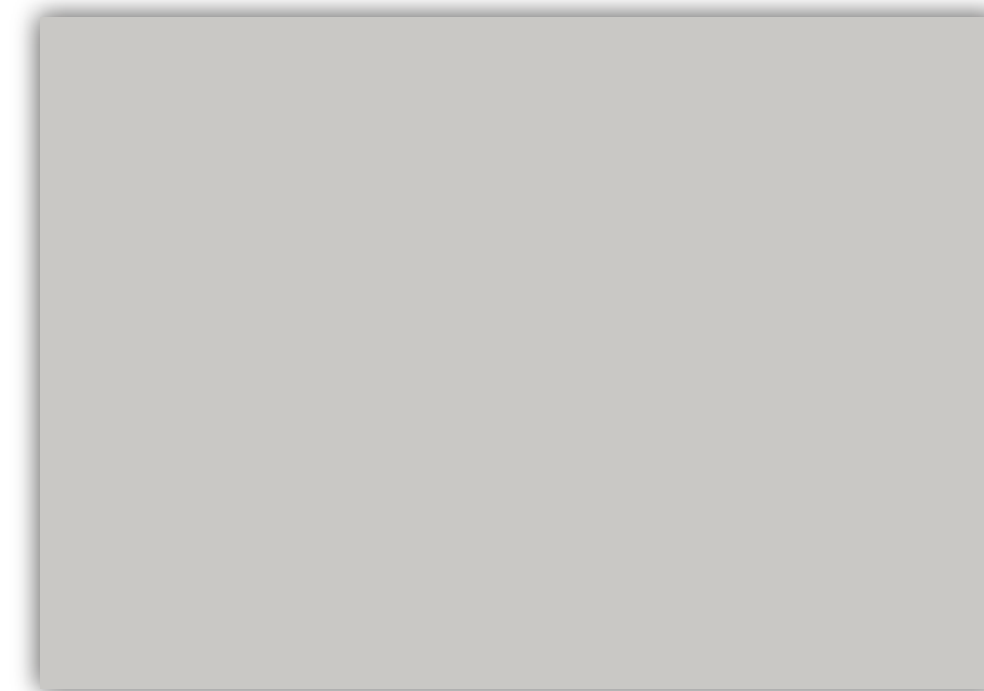

Design no. 412



Design no. 413

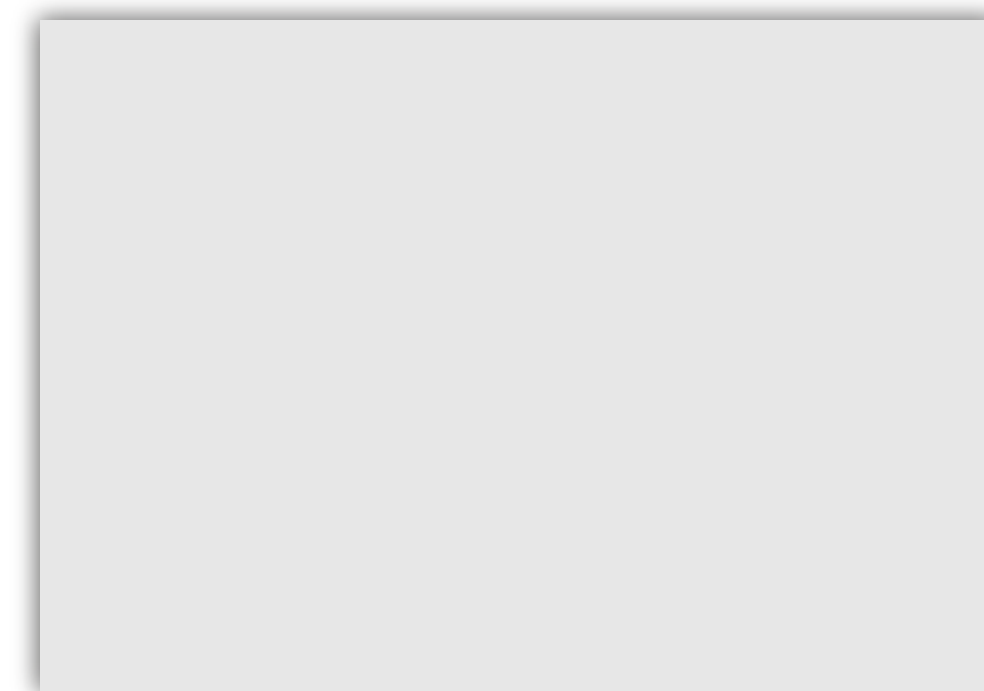

Design no. 409

SPARKLE COLLECTION



Design no. 243 *



Design no. 203



Design no. 216



Design no. 235



Design no. 208



Design no. 248



Design no. 244 *



Design no. 236



Design no. 204



Design no. 215



Design no. 414



Design no. 415



Design no. 245



Design no. 242 *

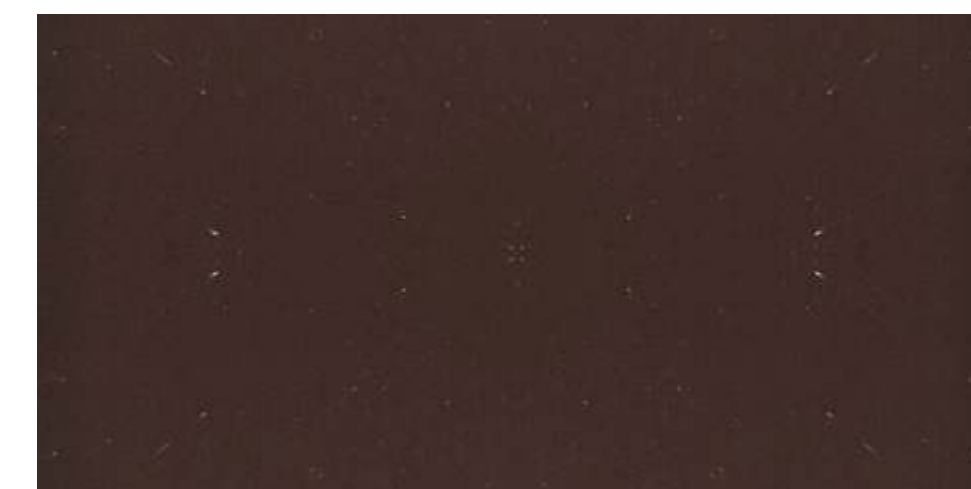

Design no. 416

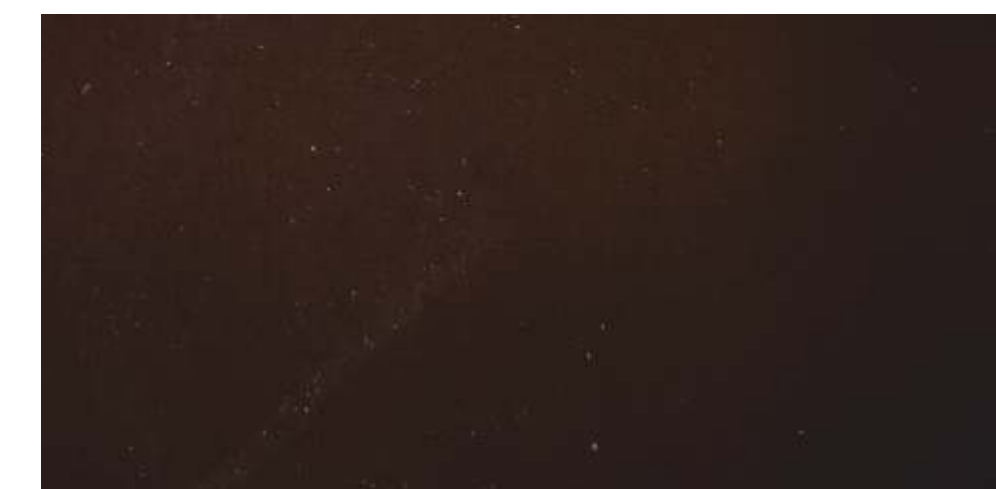

Design no. 417

SPARKLE COLLECTION



Design no. 418



Design no. 419

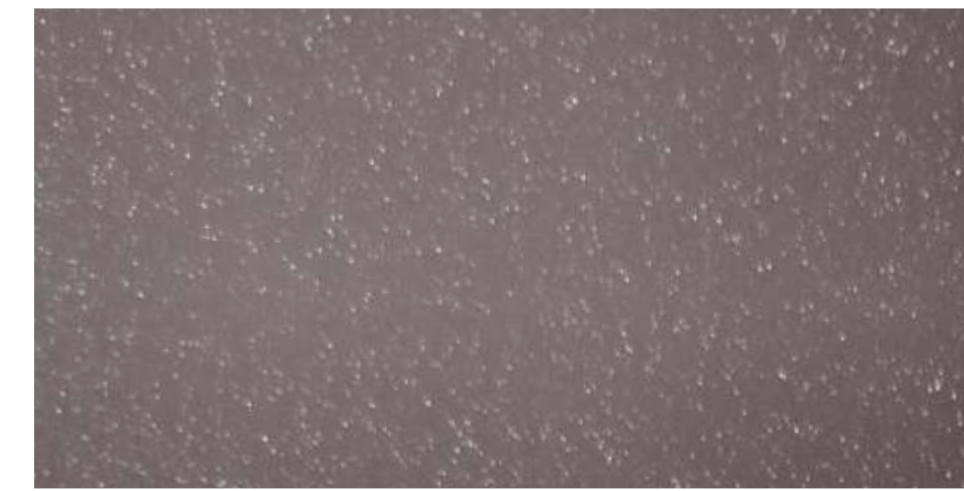

Design no. 247



Design no. 249



Design no. 421



Design no. 201



Design no. 238



Design no. 246

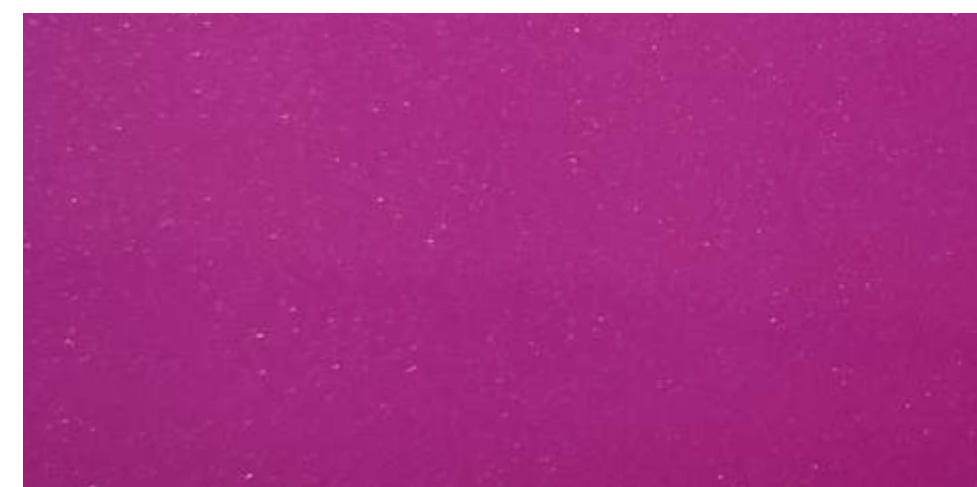

Design no. 205



Design no. 241 *



Design no. 237

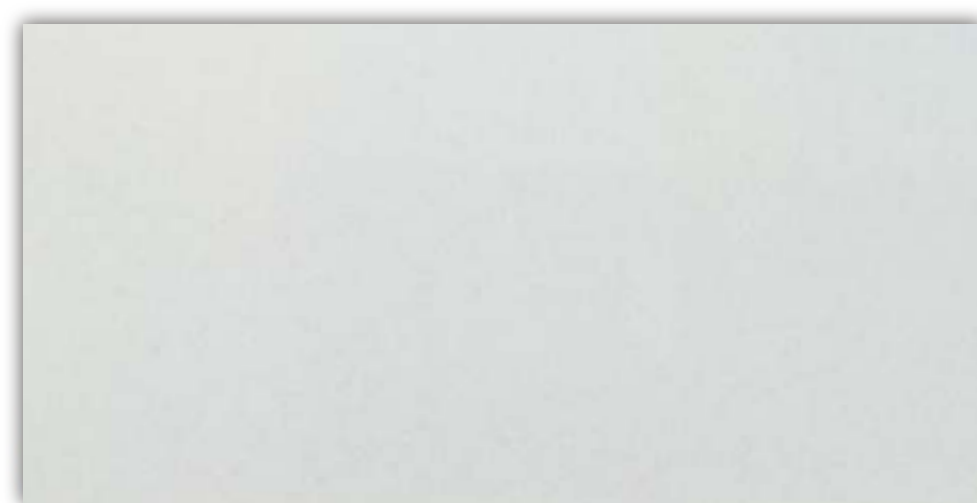

Design no. 202

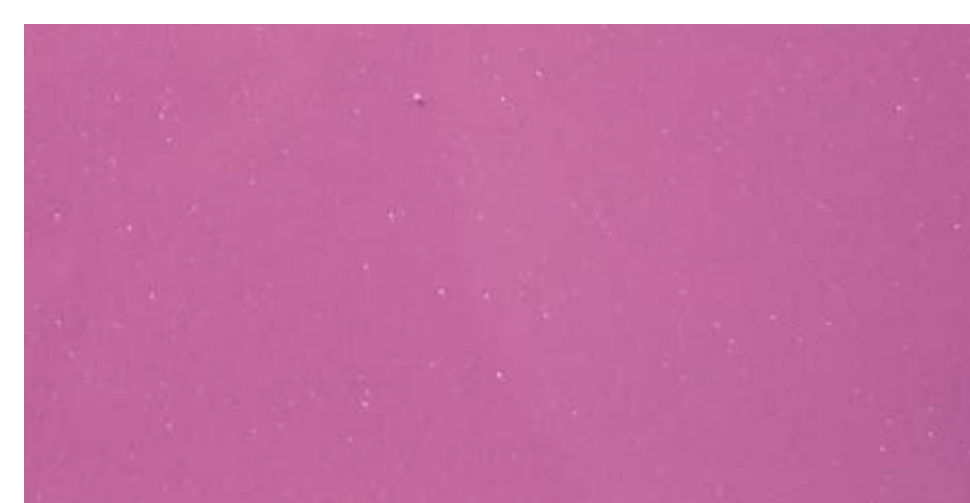

Design no. 206



Smart
HOME,
Smart

esign

3

GEOMETRIC DESIGN IS THE KEY

Strong shapes are a trademark of modern interior design, and there are numerous ways to incorporate geometric design into your house. Triangular coffee tables are popular in Mid-Century Modern design, while square sinks add a modern rustic touch to homes. Geometric forms aren't just for furniture! In the bathroom, consider using herringbone laminate to create a sleek, eye-catching aesthetic.

4

PUT OPEN SHELVING IN THE KITCHEN

This kitchen storage solution makes it easy to reach plates and utensils and makes your kitchen feel more open. If you don't want to commit to the open shelving style altogether, designate one space for shelves while keeping your cabinets for the rest of the kitchen!

VENEER COLLECTION



The Veneer Collection offers an abundance of laminates with the texture of real wood grains and is exquisitely designed for those who admire the outdoors. Perfect for staying near nature while taking in the captivating outside from within your house. A variety of imported, distinctive, and high-grade wood veneer sheets from Trend are available to assist you to add a touch of refinement and warmth to all different sorts of living spaces. These sheets are made to bring life to any living room.

VENEER COLLECTION

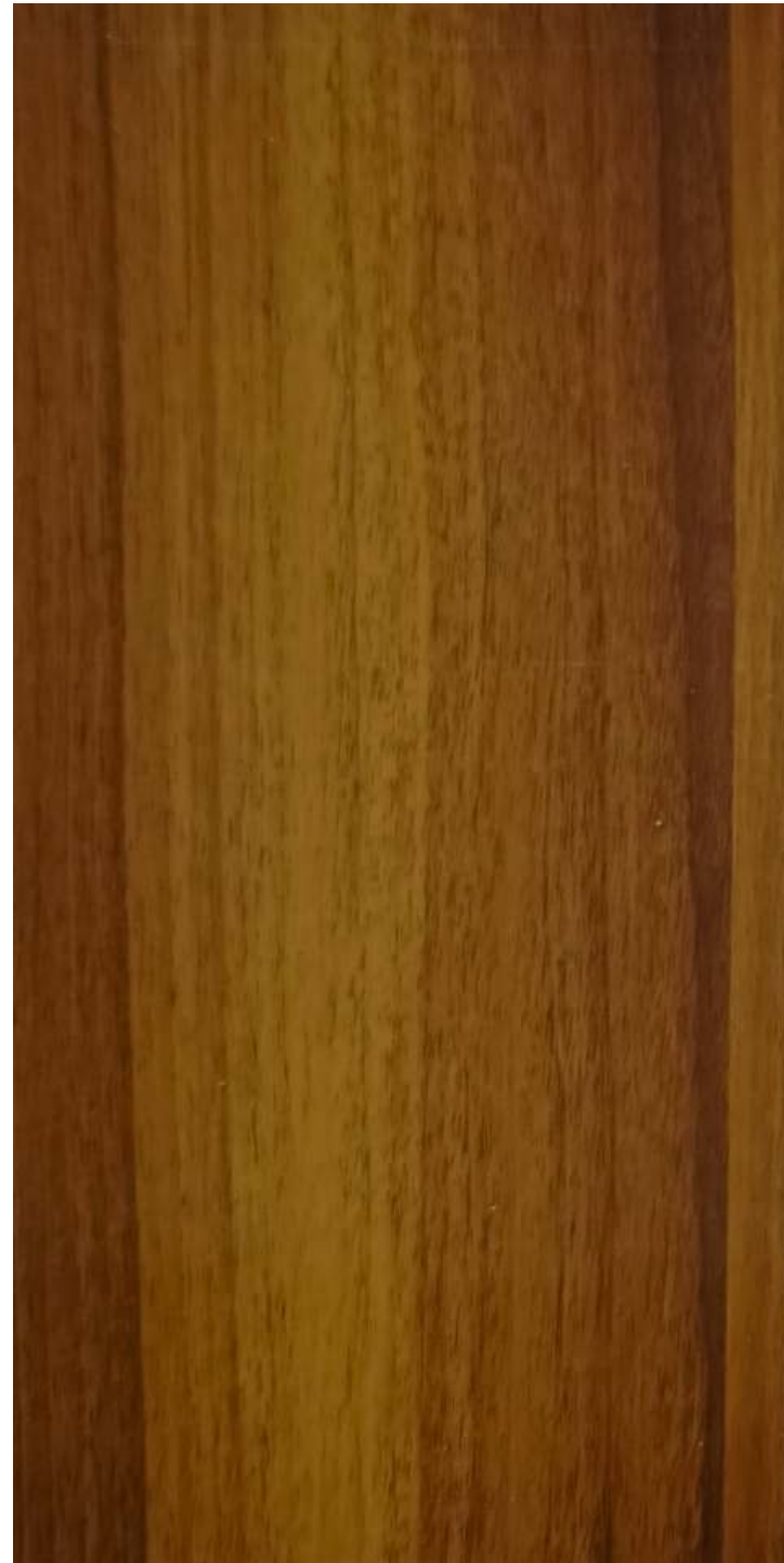

Design no. 281 **



Design no. 282 **



Design no. 286 **

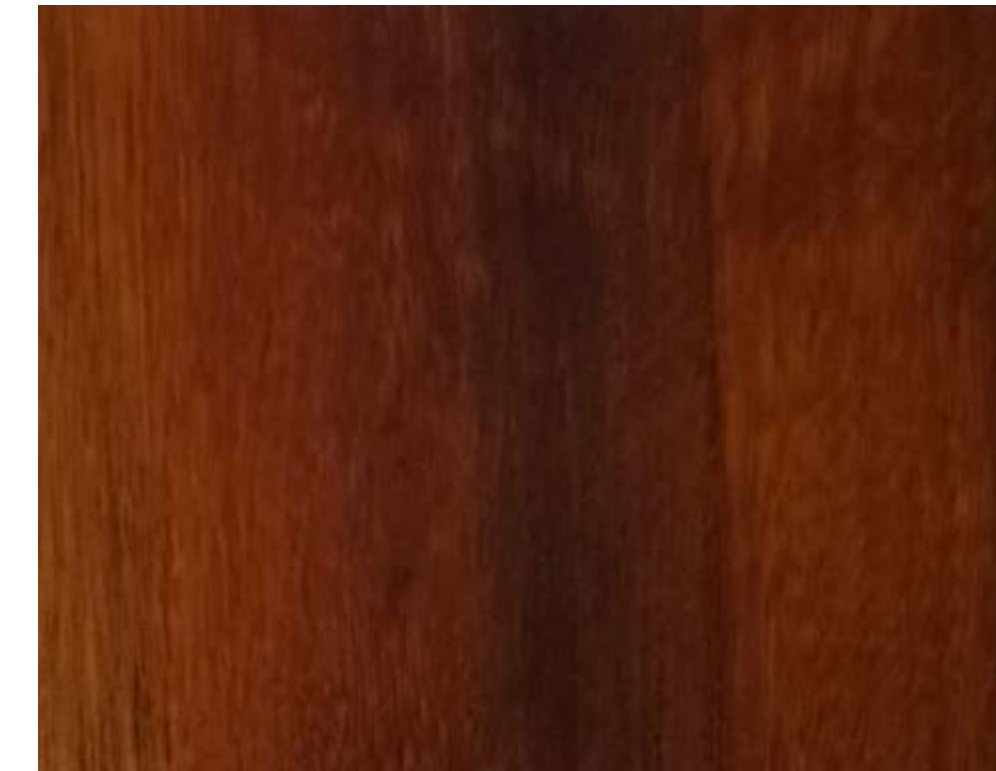

Design no. 288 **



Design no. 283 **

veneER COLLECTION



Design no. 284 **



Design no. 287 **



Design no. 290 **



Design no. 285 **



Design no. 289 **

FABRIC COLLECTION



Design no. 9007 FL ****



Design no. 9008 FL ****



Design no. 9002 FL ****

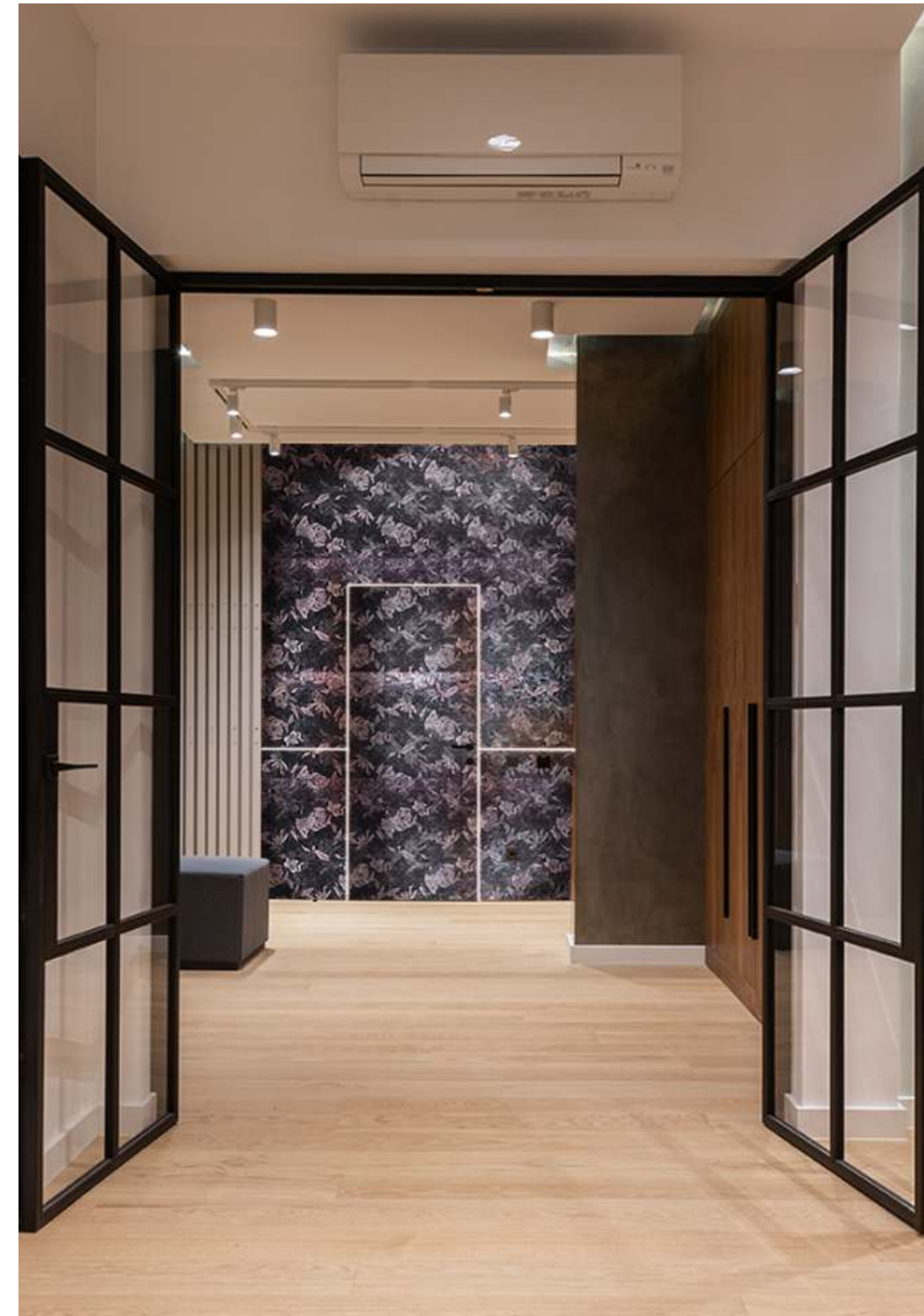

Design no. 9003 FL ****

LEARN YOUR HOME FEEL THE STYLE

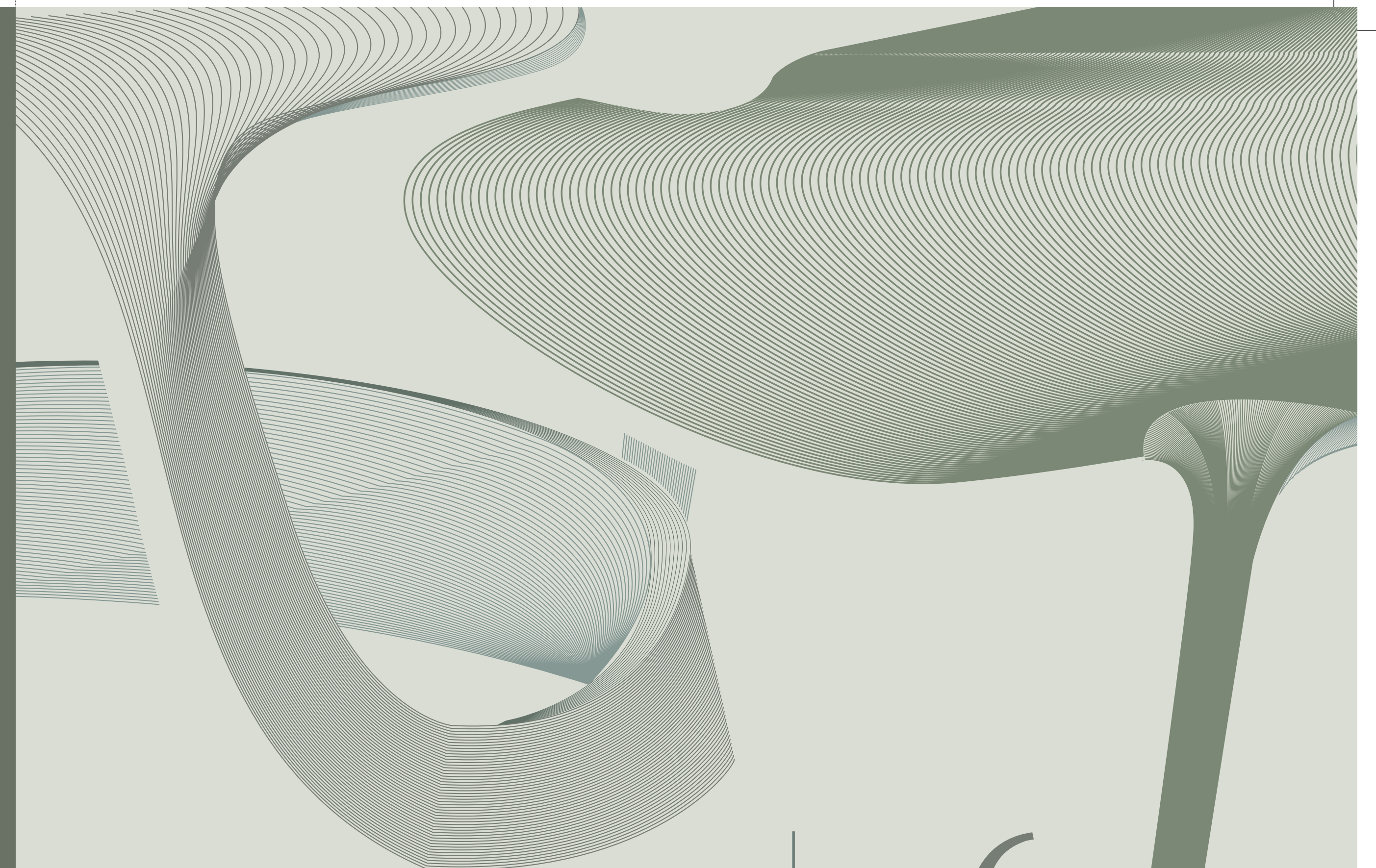

5

OPT FOR RAISED FURNITURE

Many modern furniture pieces have a raised appearance, which adds clean lines to any decor. Consider adding hairpin side tables to your bedside tables or putting an accent chair with wooden dowel legs in a plain area. Lean furniture is also ideal for smaller rooms because it creates a more open appearance!

6

BE PUNCHY WITH PATTERNS

Combining diverse patterns in the same room might be difficult, but a good idea is to use distinct patterns in comparable hues, or the same design but in different scales. Try little florals blended with giant blowsy blooms, or opt for dramatic geo forms in different colours.

FABRIC COLLECTION



Design no. 9001 FL ****



Design no. 9004 FL ****



Design no. 9005 FL ****

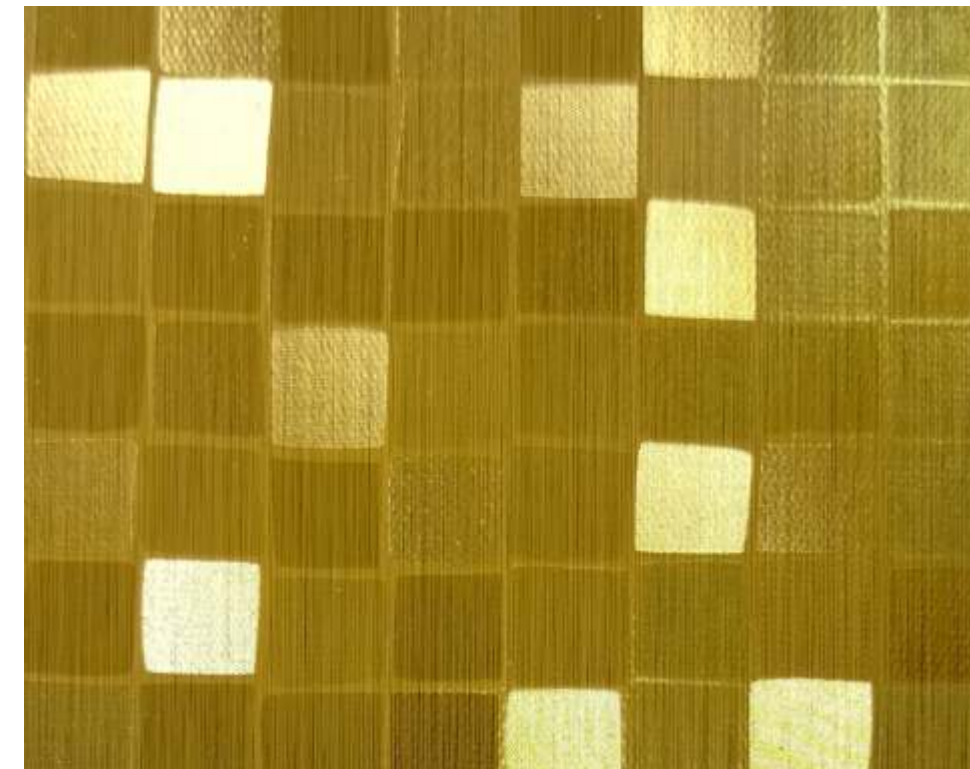

Design no. 9006 FL ****



Design no. 9009 FL ****



Design no. 9010 FL ****

FABRIC COLLECTION



Design no. 9011 FL ****



Design no. 9012 FL ****



Design no. 9013 FL ****



Design no. 9014 FL ****

FABRIC COLLECTION



Design no. 9015 FL ****



Design no. 9016 FL ****

Why to choose Best Laminates?

1
Increased
Lifetime Value

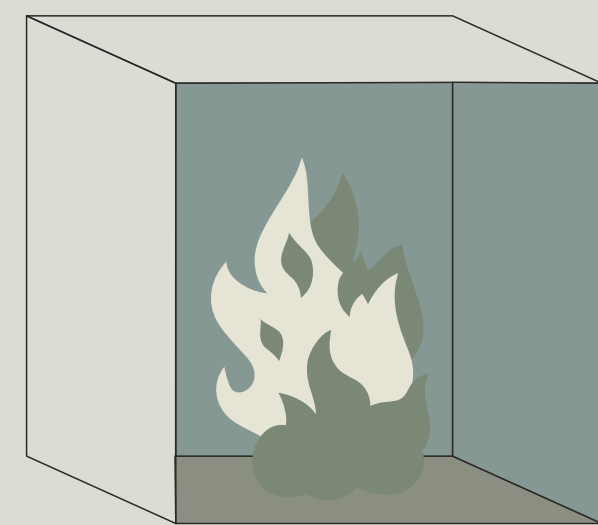
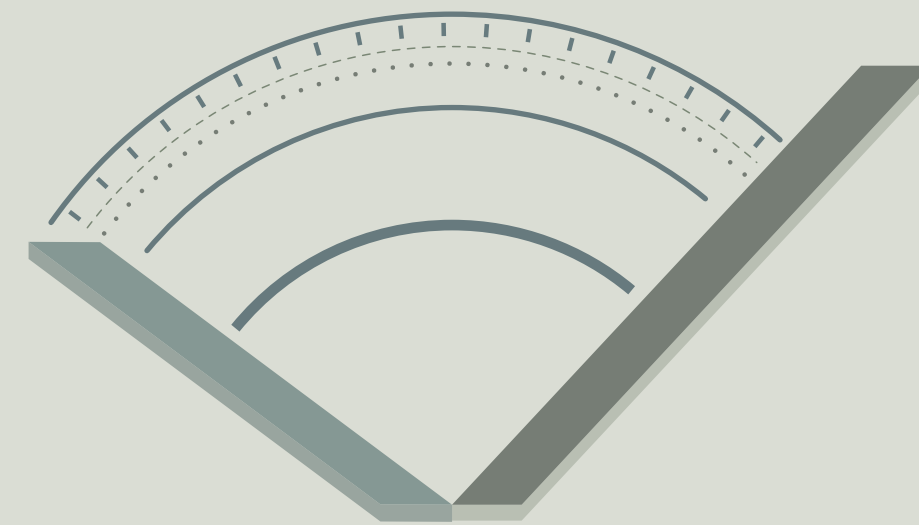

2
Fire
Retardant

3
Ease of
Installation

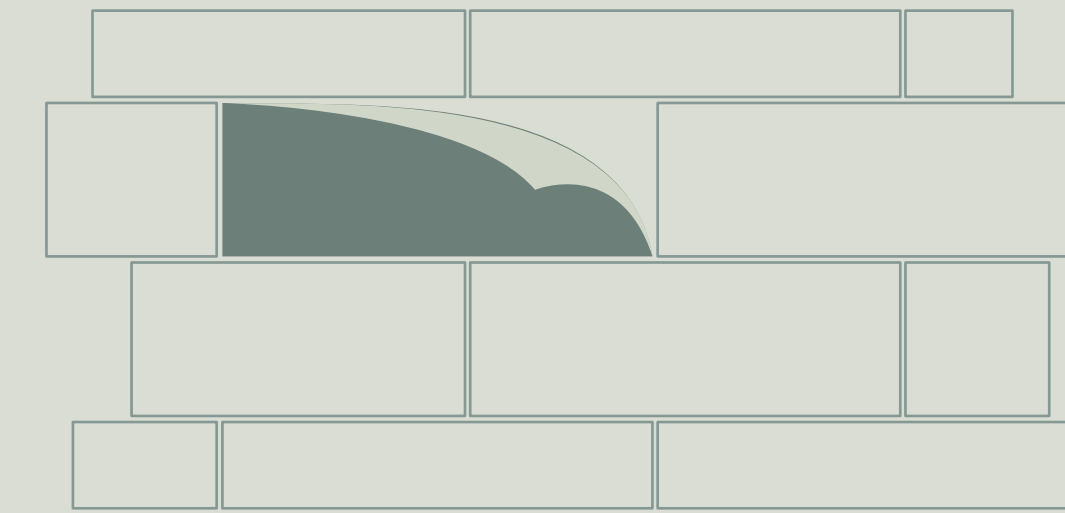
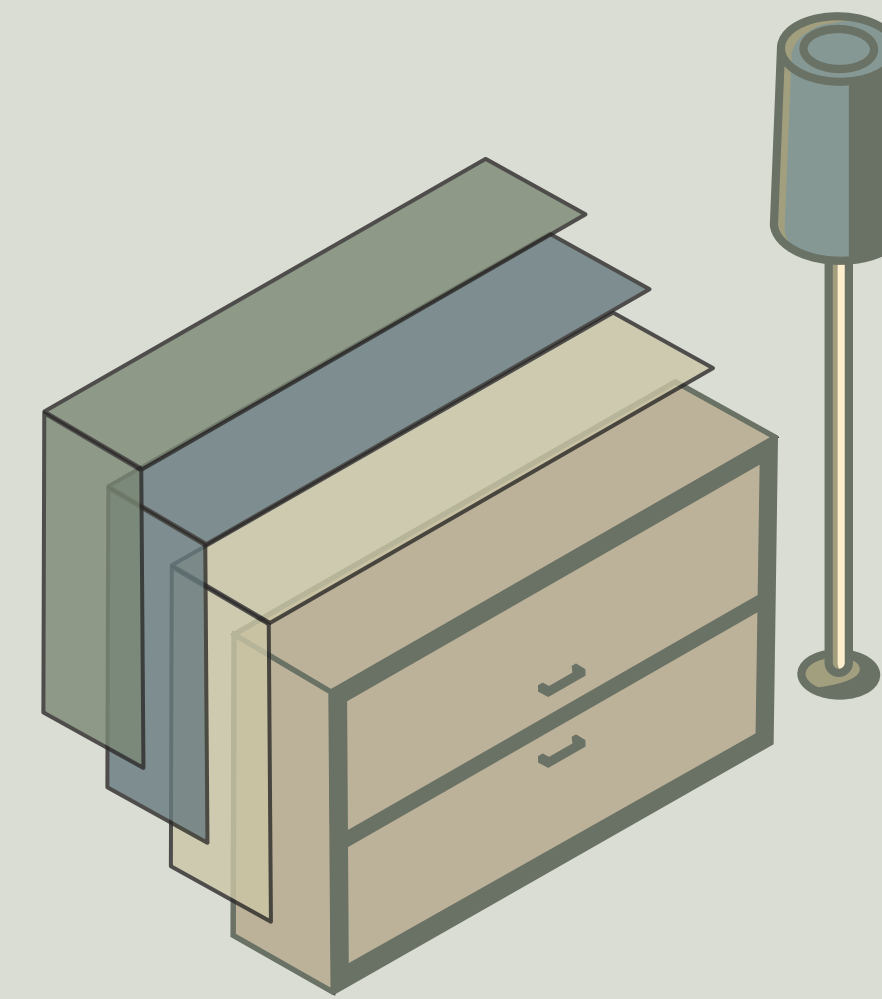

4
Colour and
Design Choices



5
Use Laminates
of Different Hues

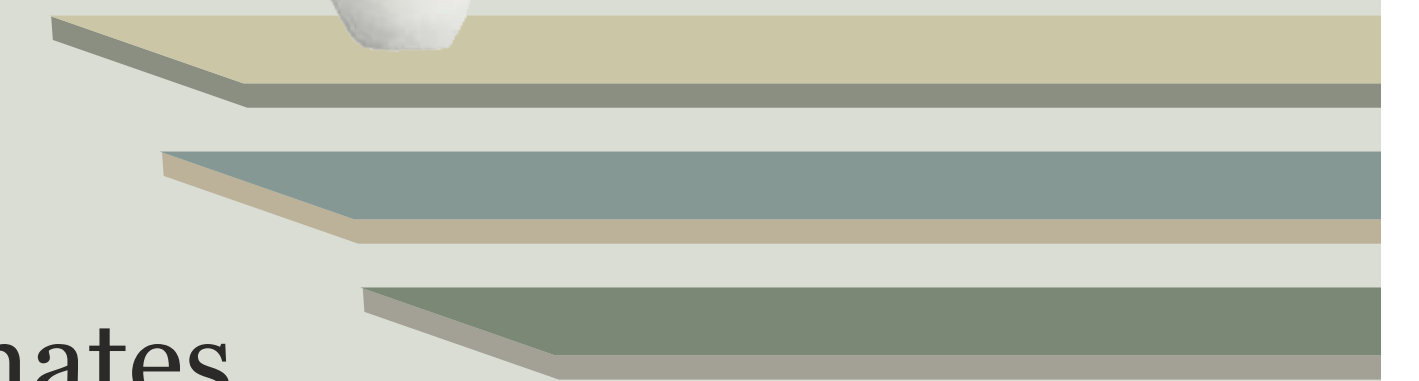

RUST SERIES



Rust Collection from Trend, drawing its attention from modern architecture, takes your interiors as close to nature as they can get. Take home any of our rust designs from our myriad collections and give nature a close call. Trend's rust series is presented to you in a sorted assortment for your ease of selection.

RUST SERIES



Design no. 8101 RS ***



Design no. 8102 RS ***

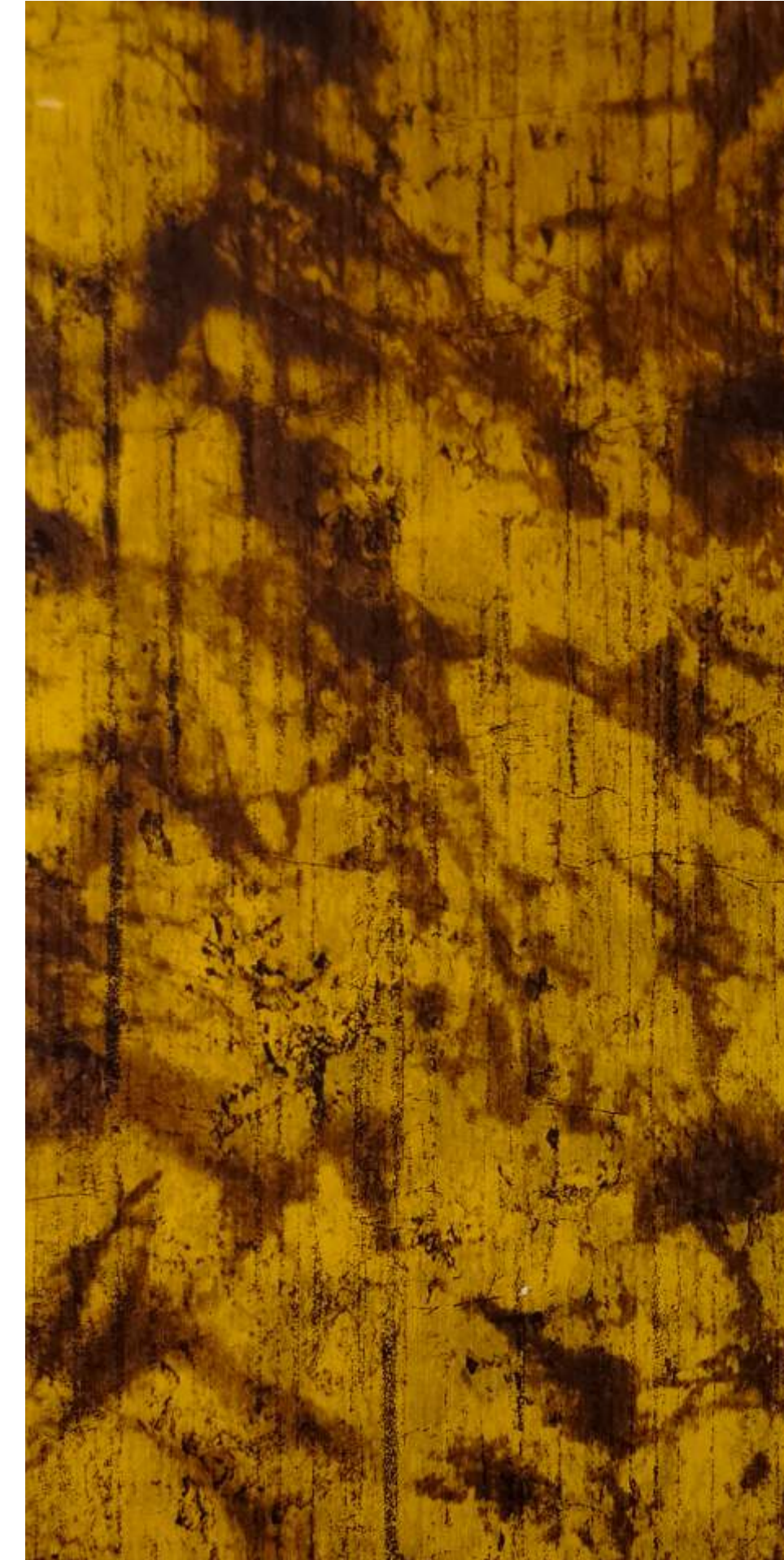

Design no. 8103 RS ***



Design no. 8104 RS ***

RUST SERIES



Design no. 8105 RS ***

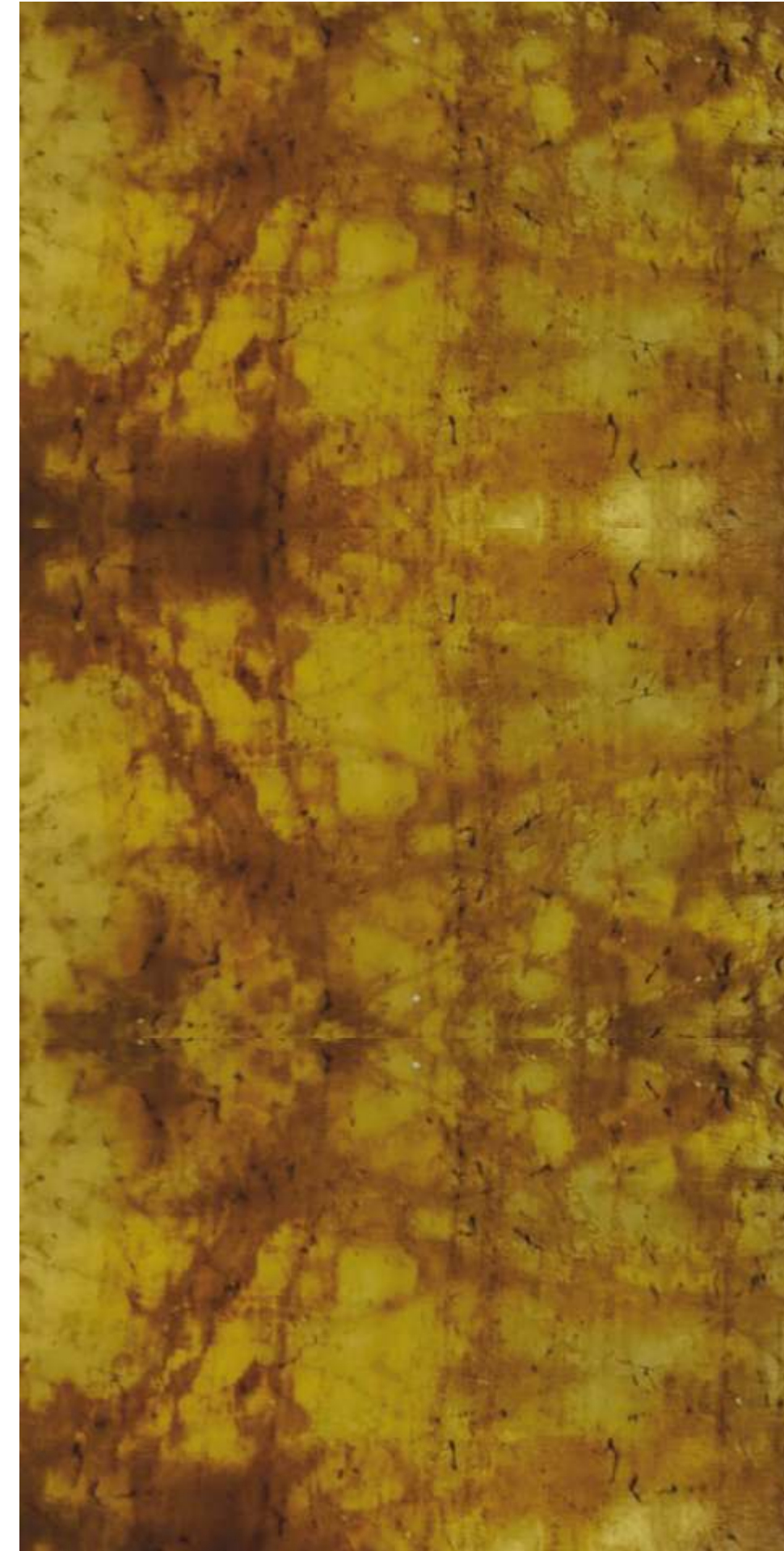

Design no. 8106 RS ***



Design no. 8107 RS ***



Design no. 8108 RS ***



Design no. 8109 RS ***

RUST SERIES



Design no. 250 **



Design no. 251 **



Design no. 301 **



Design no. 307 **



Design no. 302 ***



Design no. 304 ***



Design no. 303 ***



Design no. 305 ***



Design no. 306 ***



Design to Communicate

NOT JUST DECORATE

7

EVERY DETAIL MATTERS

This is where a professional interior designer's strength lies, in having that eye for ensuring the tiniest details, such as commissioned decorative plaster work, are perfectly and eye-catching specified to adding those finishing touches that make a space.

8

BRING A ROOM TO LIFE WITH LIGHTING

If you don't have a lot of natural light, living in the dark isn't your only option. There are a few ingenious ways you can try to boost the quantity of light coming through your windows. It's a good idea to glance outdoors and see if any trees or shrubs are blocking your windows. If there are, consider reducing them or replacing them with smaller options.

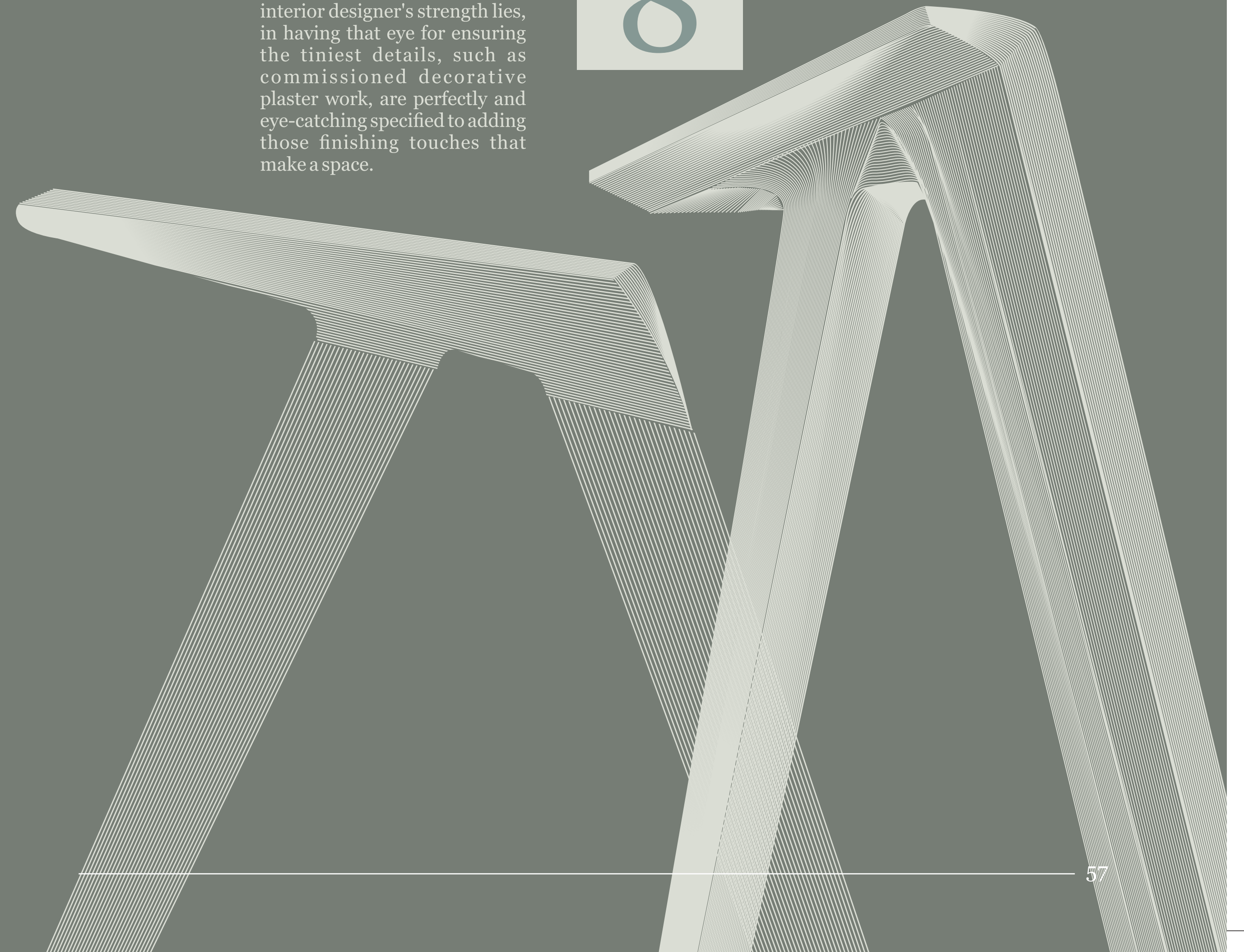

MARBLE SERIES



Design no. 312 **

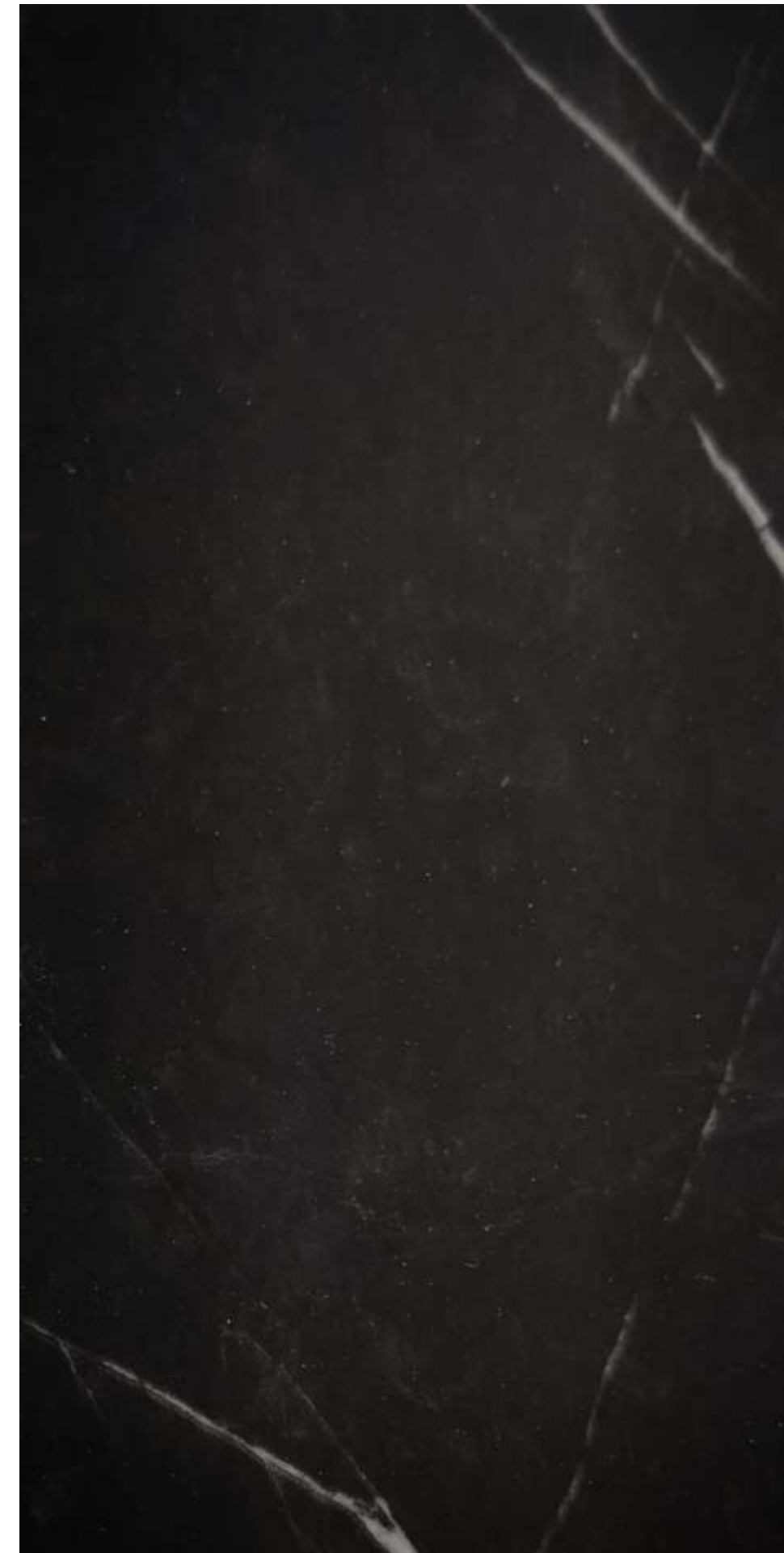

Design no. 313 **

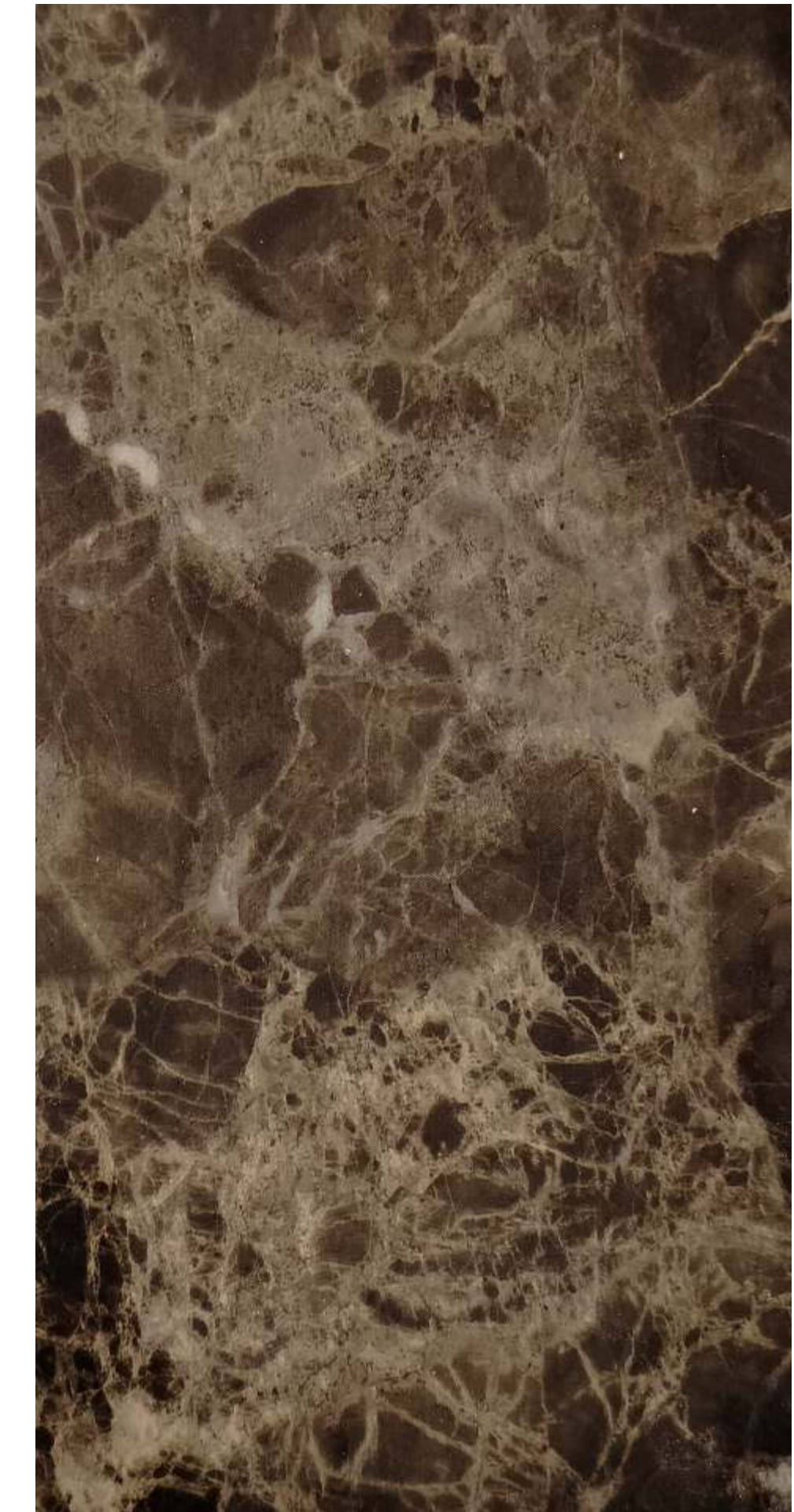

Design no. 258 *

MARBLE SERIES



Design no. 259 *



Design no. 257 *



Design no. 311 **

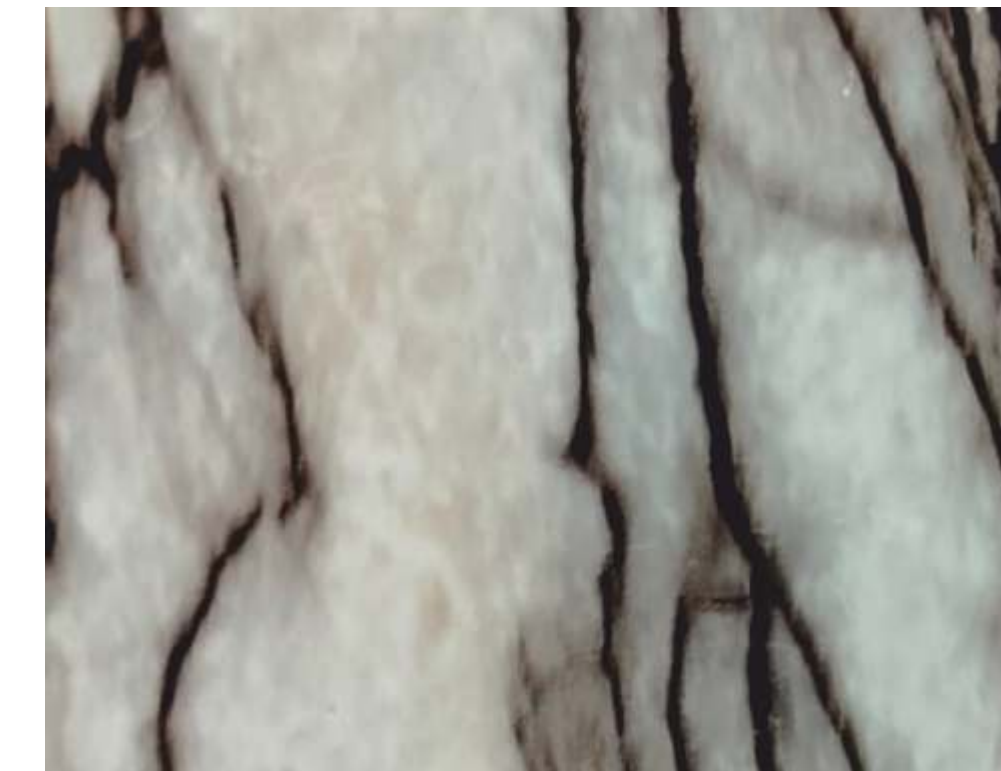

Design no. 207 *

4

Four reasons to love your Laminate Countertops

1 Low Maintenance

Laminate is generally less expensive than most other materials. Examine the largest samples available and test them in your kitchen. To maintain their appealing qualities, laminate sheets used for kitchen countertops require very little care. You only need a wipe cloth to clean the surfaces and no pricey cleaning chemicals to maintain the countertops dust-free. Remember that, unlike more expensive materials, laminate can be upgraded at a substantially lower price.

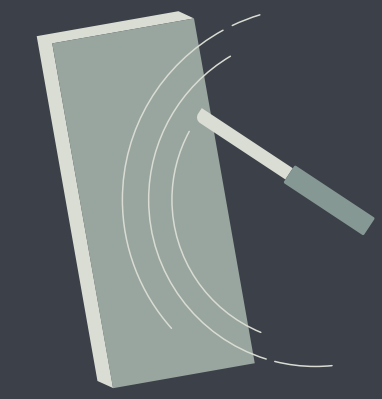
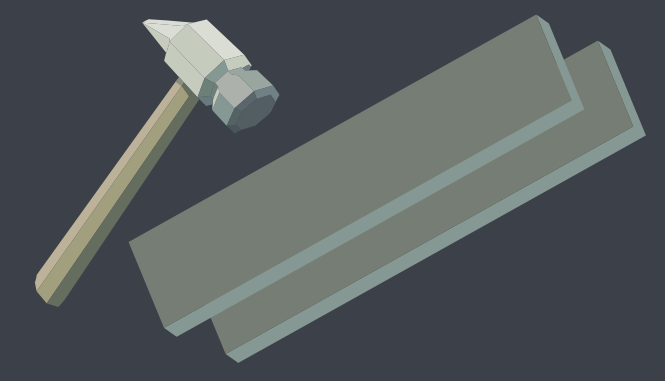

2 Stain/ Scratch Resistant

Countertops are subjected to a lot of wear and tear, so you'll want to know how they'll age before deciding on a material. Trend laminates are resistant to stains and heat and sheets in the kitchen are designed to provide excellent resistance to stains and imperfections that are frequent in the kitchen.

3 Wide Range of Varieties

The colors & varieties available when it comes to selecting countertops are immense. It's safe to say that with Trend countertops, every part of your vision will be covered with ease. The wide range of varieties is a big benefit as you can't get the same with other countertops materials.



4 Resonates with Natural Beauty

Natural is always better than artificial. No matter how many artificial tactics & materials you use to decorate your kitchen, nothing can beat the natural beauty that Trend countertops offer. Trend countertops come from slabs and thus the natural beauty they offer is in abundance. So, if you are a nature lover and looking to incorporate nature into your kitchen setup, a Trend countertop is your definite answer.

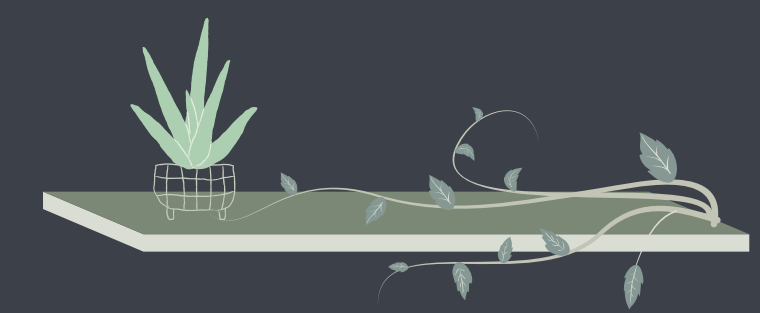

FRENCH STONE



French Stone collection represents the purest form of resonating colors, taking a cue from Ancient Architecture. This collection presents you with limitless choices for an application that would make your interior spaces light up. Light, Dark, Subtle, or Blingy, we have got all of your color palettes covered in our amazing French Stone collection.

FRENCH STONE



Design no. 256 *



Design no. 210 *



Design no. 263 *



Design no. 264 *



Design no. 262 *



Design no. 267 *



Design no. 268 *



PVC CORE LAMINATES



Trend offers environmentally friendly PVC laminates that can grace your interiors with their incredibly stunning designs and textures. These decorative PVC laminates can offer any surface a fresh, modern twist because they come in a wide variety of designs, colors, and patterns. Trend's PVC sheets are not only aesthetically pleasing but also corrosion and waterproof, termite resistant, and flexible to 90 degrees. The laminates are the ideal way to update your interior space because they are simple to apply on a good-quality substrate and simple to clean.

PVC CORE LAMINATES

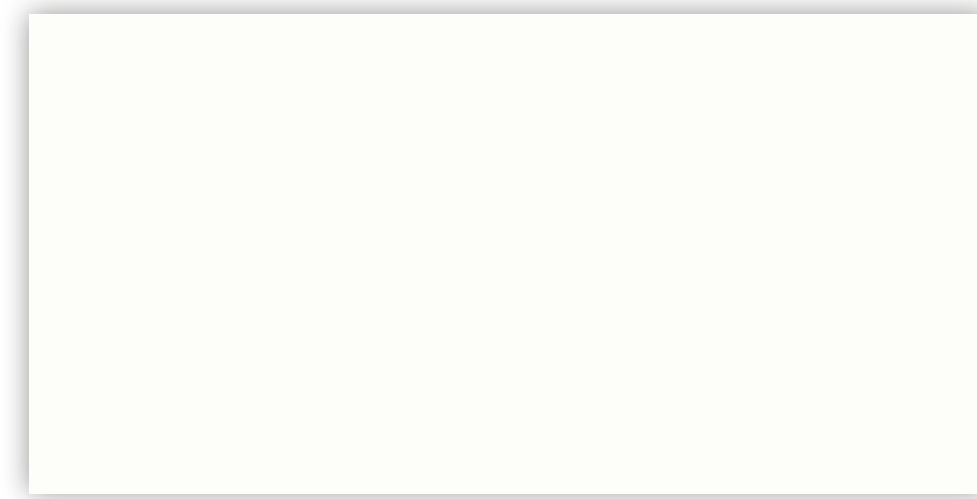

Design no. 601 HG **



Design no. 602 HG **



Design no. 609 HG **



Design no. 606 HG**

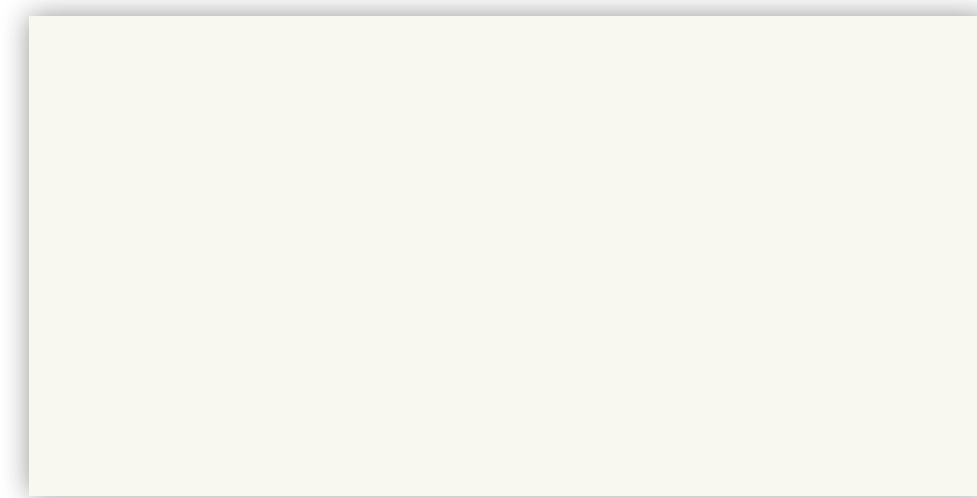

Design no. 603 HG**



Design no. 604 HG **



Design no. 607 HG **



Design no. 614 HG **



Design no. 605 HG **



Design no. 611 HG **



Design no. 612 HG **



Design no. 613 HG **



Design no. 608 HG **

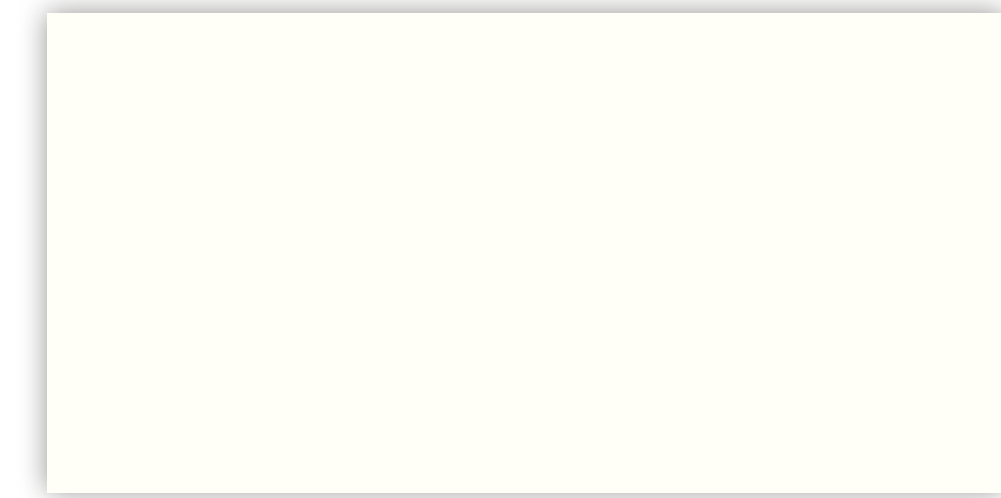

Design no. 615 MATT **

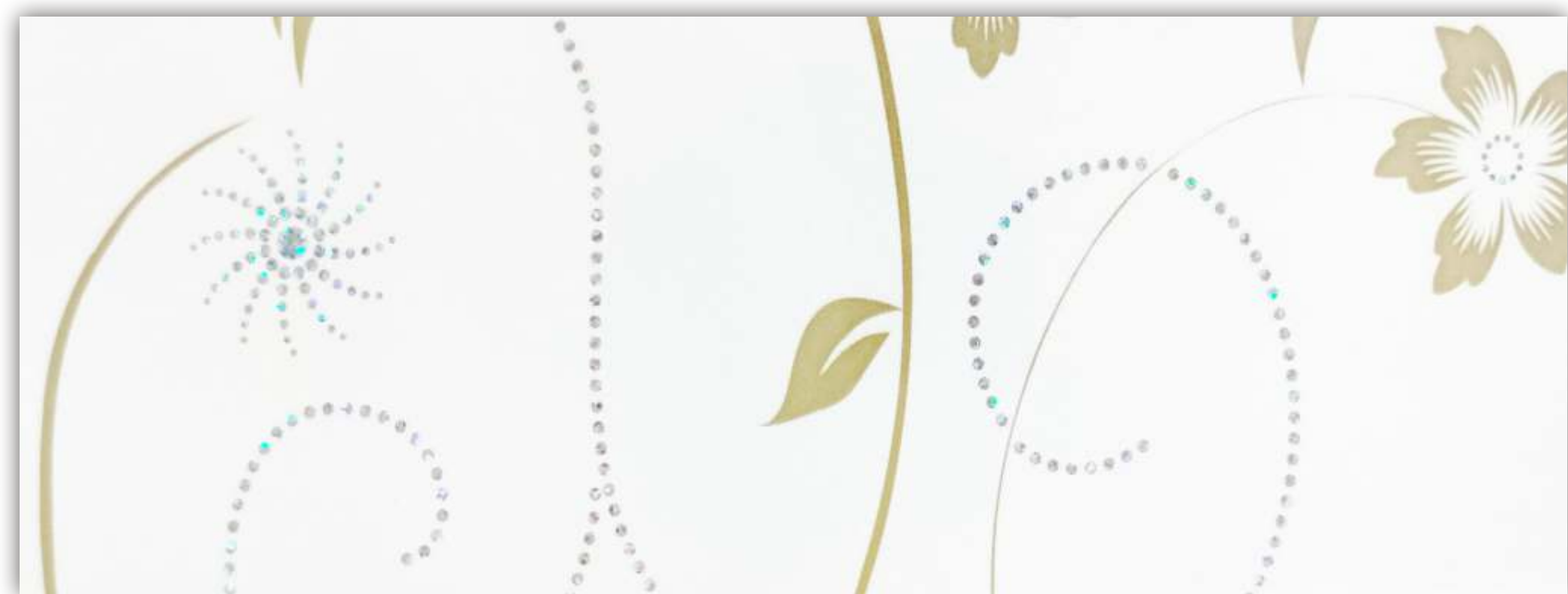

Design no. 9024 LL **



Design no. 269 *

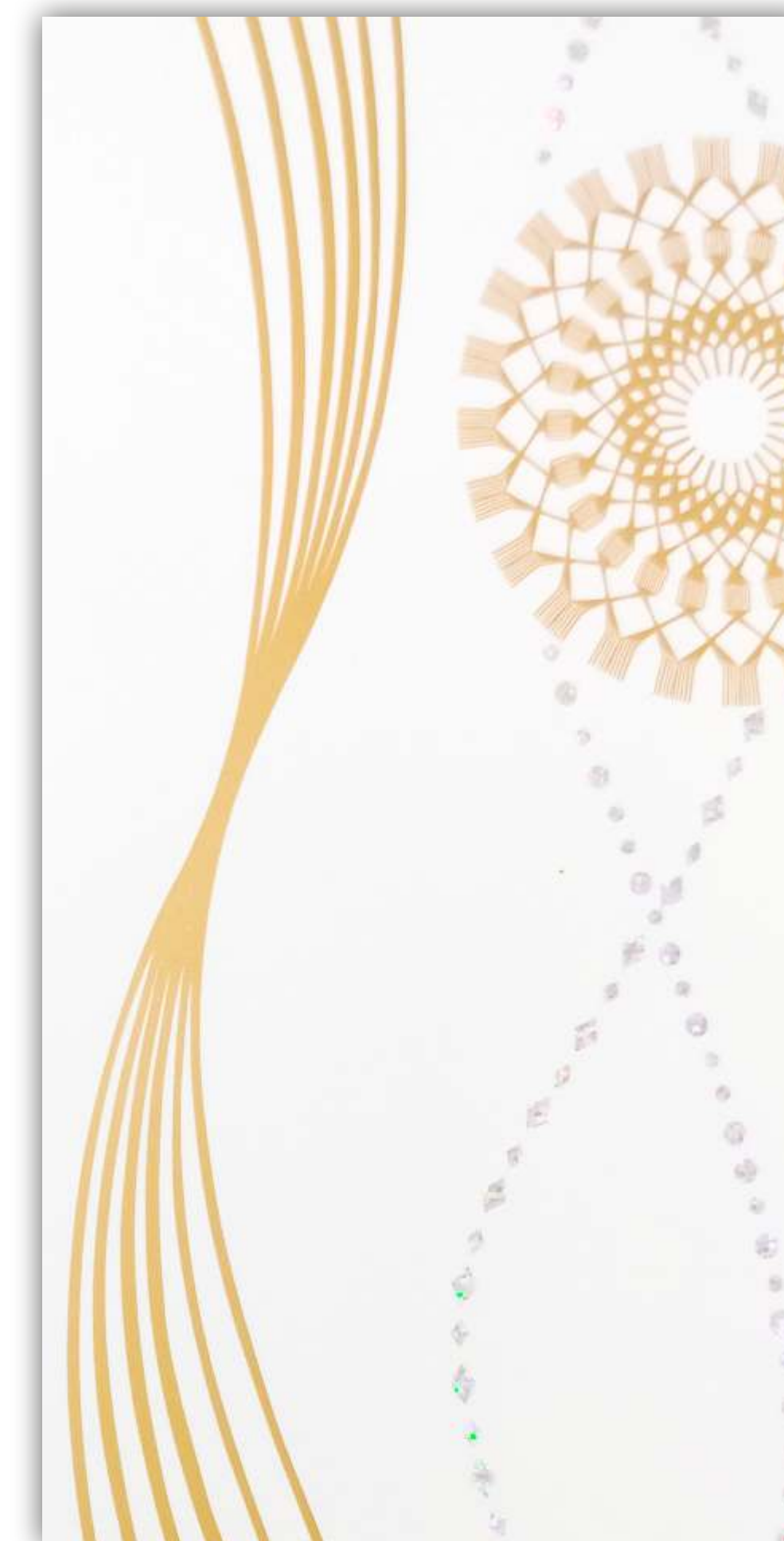

Design no. 9015 LL **



Design no. 271 *



Design no. 270 **



Design no. 229 **



Design no. 9016 LL **



Design no. 230 *

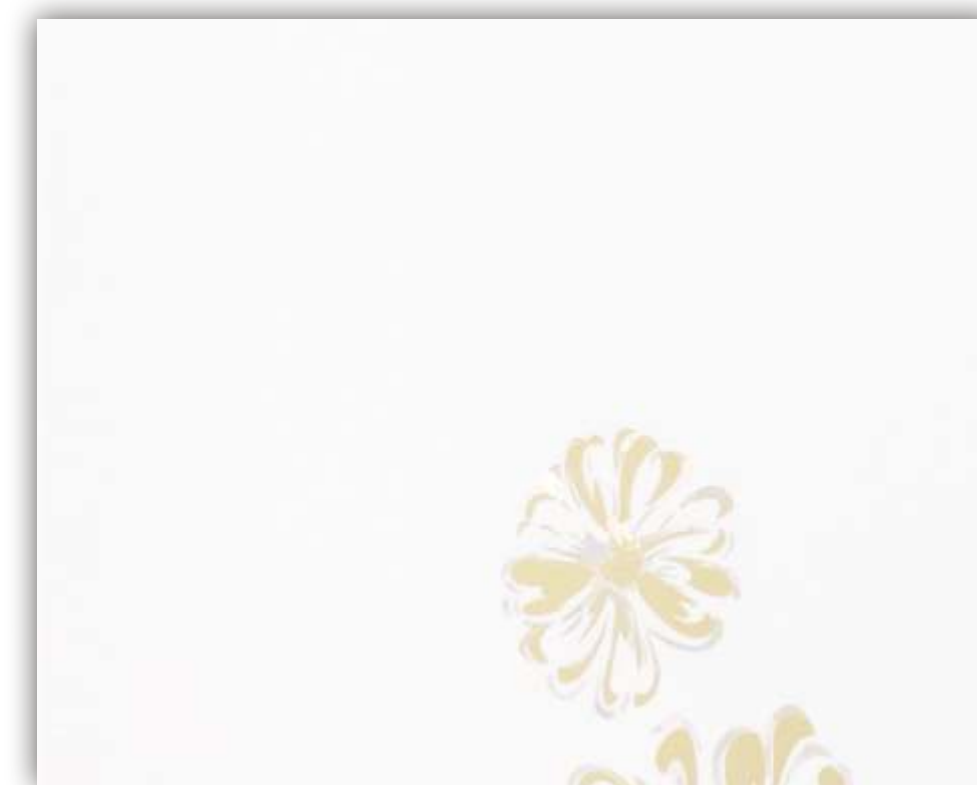

Design no. 231 **



Design no. 239 *



Design no. 9017 LL

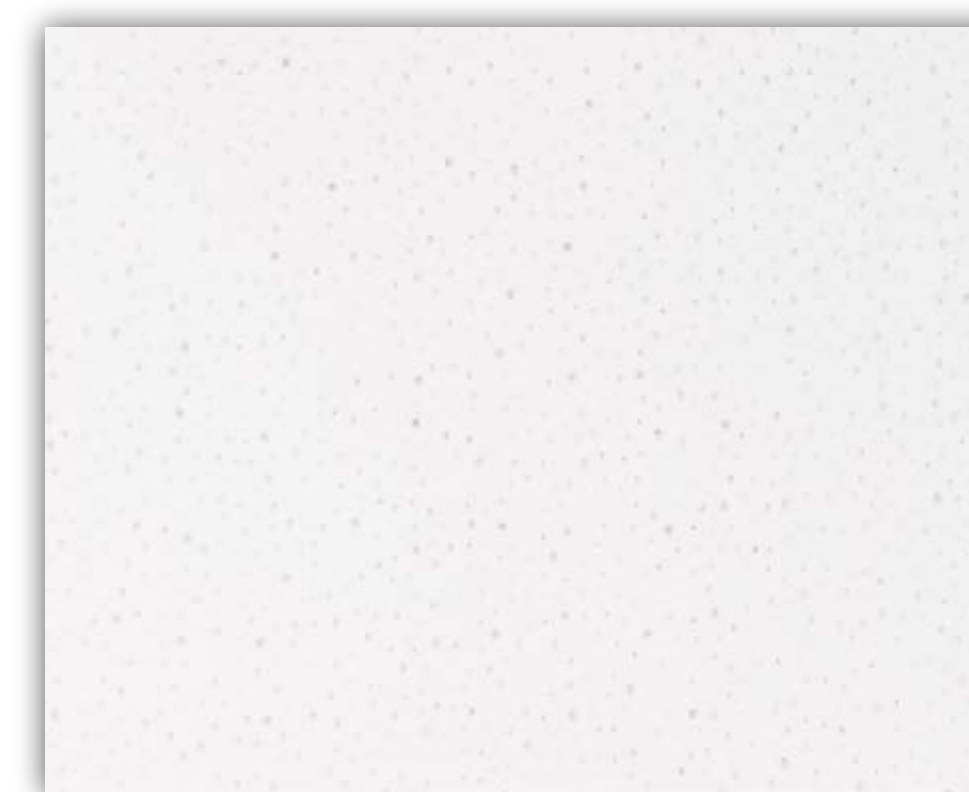

Design no. 240 *

We don't renovate spaces
We transform them

9

DECORATE YOUR INTERIORS IN THREES

When it comes to decorating your space, it can be beneficial to decorate in threes. When people have a lot of objects dispersed over their houses, the eye becomes overwhelmed and doesn't know where to look. When they are arranged in groups of three, the attention is pulled to the topmost piece and descends.

10

GO BOLD WITH MODERN ART

Art galleries can help with deciding on a color palette for a home's interior decor. Your guests will be astounded when they see these magnificent paintings on your wall. However, if you're on a tight budget, flea markets and bazaars are excellent places to hunt for low-cost, high-quality art and décor. As a focal point, large artwork with minimal or no frame hanging on the wall is great. Choose a modest art series for huge walls rather than a gallery wall arrangement, which will detract from the modernist impact.



Design no. 222 *



Design no. 221 *



Design no. 225 *

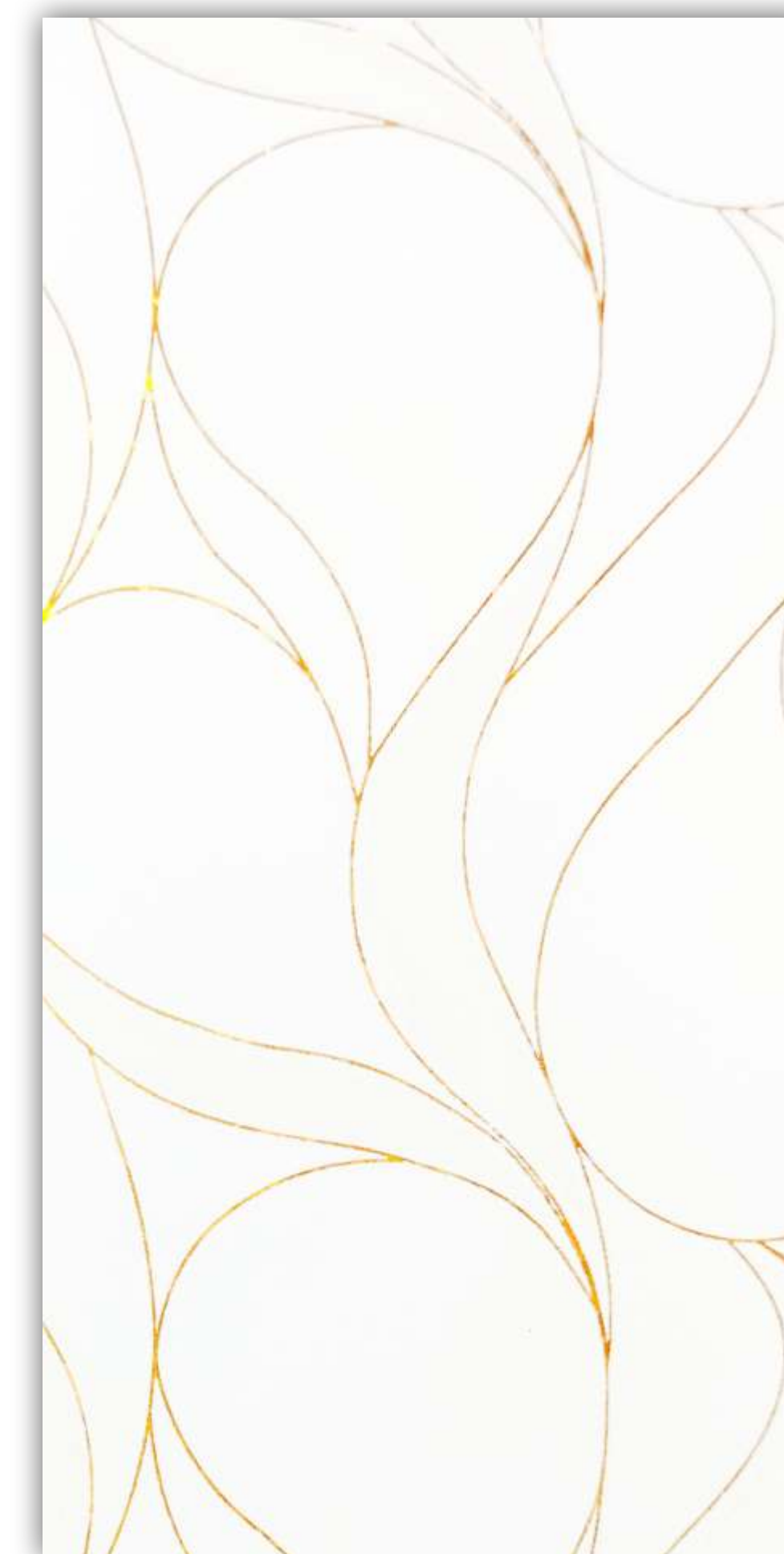

Design no. 226 *



Design no. 228 *

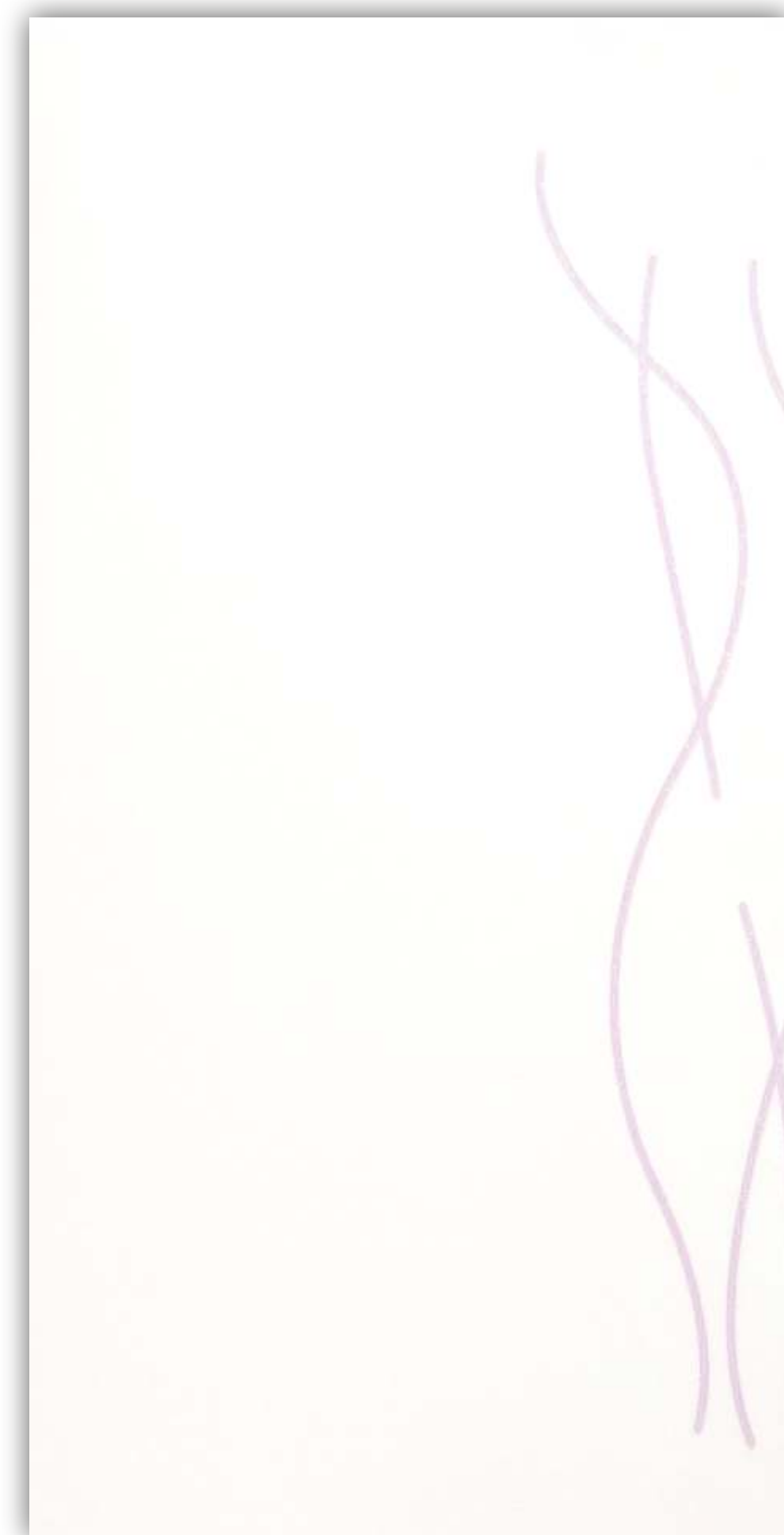

Design no. 223 *



Design no. 227 *



Design no. 212 *

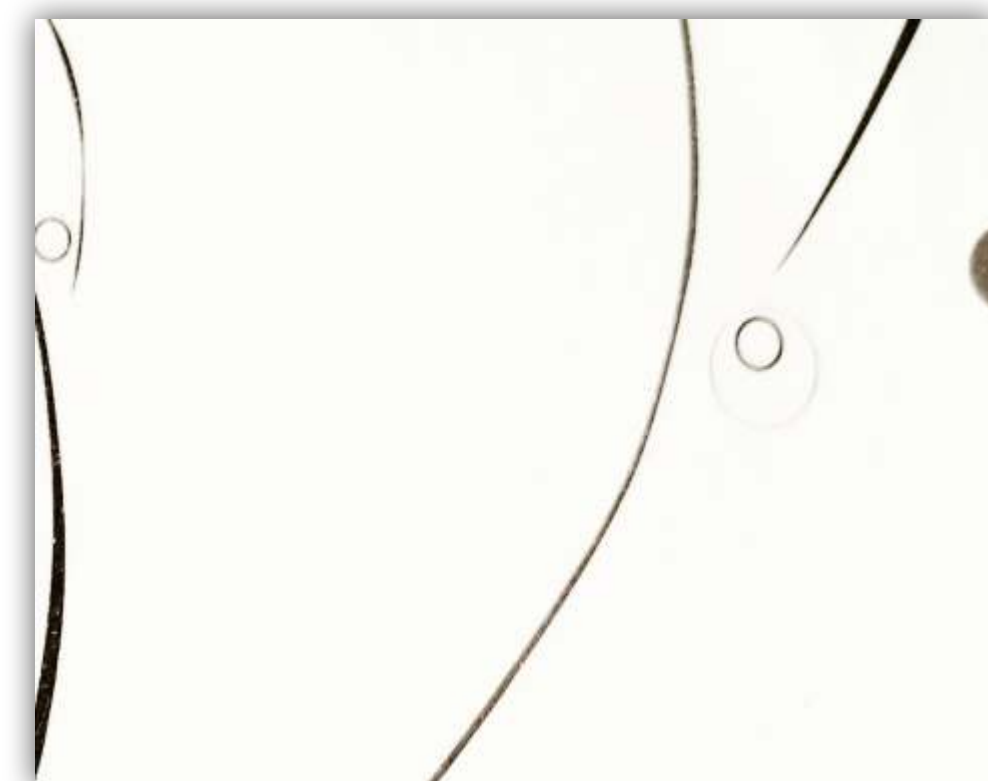

Design no. 219 *

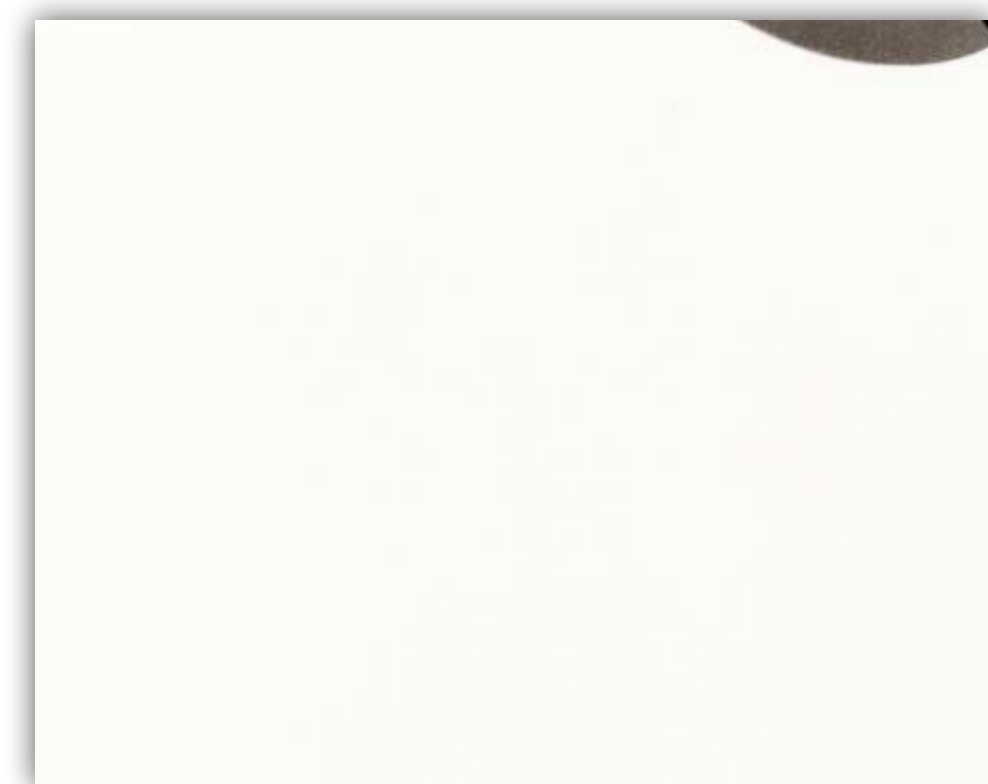

Design no. 220 *



Design no. 213 *



Design no. 214 *



Design no. 260 **



Design no. 218 *

Let your
HOME
make an
IMPRESSION.